



## **Instruction manual**

**TE67X000002150 Ethernet module**

**- Status and weight transfer using EtherNetIP**

**Instruction manual no.: IM-TE91K013-EN2**

**ESE02419EN**

**Date of issue: August 19, 2014**

**First published: March 6, 2013**

Original manual



# 1. Contents

1. Contents .....	1
2) Introduction.....	3
2.1 Introduction .....	3
2.2 Target group .....	3
2.3 Limitation of liability.....	3
2.4 Intended use .....	4
2.5 EtherNetIP specification.....	4
2.6 ATEX (Ex) specification .....	4
3) Data Exchange.....	5
3.1 EtherNetIP communication .....	5
3.2 Data formats .....	6
3.3 Unsigned integer format (16 bit) .....	6
3.4 Signed integer format (32 bit) .....	6
3.5 Scaling .....	7
3.6 Measurement time .....	7
3.7 Filtering .....	8
4) Data Processing.....	9
4.1 Zeroing, calibration and weight calculation .....	9
4.2 Corner calibration of weighing system .....	9
4.3 Calculation of uncalibrated system weight.....	10
4.4 System calibration of weighing system .....	10
5) Installation of system.....	11
5.1 Checklist during installation .....	11
6) Hardware description .....	12
6.1 TE67X000002150 overview.....	12
6.2 Connection of power (J2).....	13
6.3 Connection of load cells (J7).....	13
6.4 RS485 connector (J1).....	14
6.5 RS232 connector (J4).....	14
6.6 Ethernet connector (J8) .....	14
6.7 DIP-switch settings .....	15
6.8 Light Emitting Diodes (LEDs).....	15
7) Maintenance, Service / Repair & Warranty .....	18
7.1 Maintenance .....	18
7.2 Service / Repair .....	18
7.3 Warranty conditions .....	18

8) How to contact Alfa Laval Tank Equipment.....	19
9) Appendices.....	20
9.1 Appendix A – Status Codes .....	20
9.2 Appendix B – Setup with Terminal Interface .....	21
9.3 Appendix C – Allen Bradley connection.....	25
9.4 Appendix D – Omron connection .....	25
9.5 Appendix E – Download of new software .....	26
10) EC Declaration of conformity.....	31

## 2) Introduction

### 2.1 Introduction

This document describes the use of a TE67X000002150 Ethernet module from Alfa Laval Kolding A/S, when it is equipped with the program listed on the front page.

With the program specified on the front page, the TE67X000002150 Ethernet module is capable of transmitting weight and status for up to 4 load cells in a single telegram. Each load cell is connected to the Ethernet module through a load cell interface module.

It is possible to connect the TE67X000002150 Ethernet module to an EtherNet/IP network, where it will act as a slave. It will then be possible from the EtherNet/IP master to read status and weight for each of the connected load cells. Functions as zeroing, calibration and calculation of system weight(s) must be implemented outside the TE67X000002150 in the EtherNet/IP master.

Exchange of data between master and slave takes place as described in the following.

**Note:** The illustrations and specifications contained in this manual were effective at the date of printing. However, as continuous improvements are our policy, we reserve the right to alter or modify any unit specification on any product without prior notice or any obligation.

© Alfa Laval Corporate AB

*This document and its contents is owned by Alfa Laval Corporate AB and protected by laws governing intellectual property and thereto related rights. It is the responsibility of the user of this document to comply with all applicable intellectual property laws. Without limiting any rights related to this document, no part of this document may be copied, reproduced or transmitted in any form or by any means (electronic, mechanical, photocopying, recording, or otherwise), or for any purpose, without the expressed permission of Alfa Laval Corporate AB. Alfa Laval Corporate AB will enforce its rights related to this document to the fullest extent of the law, including the seeking of criminal prosecution.*

- Technical modifications reserved –

### 2.2 Target group

WARNING! To avoid operator hazards and damages of the device, the following instructions have to be worked out by qualified technical personnel.

### 2.3 Limitation of liability

By non-observance of the instruction manual, inappropriate use, modification or damage, no liability is assumed and warranty claims will be excluded.

## 2) Introduction (continued)

### 2.4 Intended use

The Alfa Laval TE67X000002150 Ethernet module has, according to the type, been developed for Tank weighing applications. It is the operator's responsibility to check and verify the suitability of the device for the intended application. If any doubts remain, please contact our local Alfa Laval Company in order to ensure proper usage. Alfa Laval Kolding A/S is not liable for any incorrect selections and their effects.

- The technical data listed in the current data sheet are engaging and must be complied with. If the data sheet is not available, please order or download it from our homepage (<http://www.alfalaval.com>)

### 2.5 EtherNetIP specification

The TE67X000002150 EtherNet module confirms with the following EtherNetIP specifications:

<b>Protocol:</b>	EtherNetIP
<b>Media:</b>	Ethernet
<b>Module type:</b>	Slave(/Target)
<b>Communication settings:</b>	10MB/s, Half duplex
<b>IP-Address:</b>	Fixed (default 192.168.1.199)
<b>Ethernet connection:</b>	RJ45/Cat5
<b>System setup:</b>	RS232 terminal interface

### 2.6 ATEX (Ex) specification

<p><b>Important ATEX information</b></p> 	<p>Load cell modules and instrumentation <u>must be placed outside the hazardous zone</u> if the load cells are used in hazardous ATEX (Ex) area. Furthermore, only ATEX certified load cells and instrumentation can be used in ATEX applications.</p>
--	---

### 3) Data Exchange

#### 3.1 EtherNetIP communication

Ethernet communication with the TE67X000002150 Ethernet module uses a single Assembly consisting of 26 bytes data as specified in the EDS file:

Assembly:	Assem3	Input
Assembly instance:	103	(0x67)
Connection:	Connection1	Exclusive Owner
Transfer class:	Class 1	

The data bytes are structured like this:

Lc Register		Lc Status(0)		Lc Signal(0)			
0	1	2	3	4	5	6	7

Lc Status(3)		Lc Signal(3)			
20	21	22	23	24	25

The byte order for the individual parts of the telegram is LSB first. In the following bit 0 will represent the least significant bit in a register.

**LcRegister** is a word (two bytes) that constitute a bit register for indication of connected load cells detected during power on. Hence bit 0-3 will be ON, if the corresponding load cell (address) was detected during power on. **LcRegister** is always transferred in **16 bit unsigned integer** format.

Furthermore bit 15 will be always ON, while bit 14 will toggle ON and OFF with 1hz (=500ms ON, 500ms OFF)

**LcStatus(X)** is a word (two bytes) that constitute a register containing the actual status for load cell **X**. **LcStatus(X)** is always transferred in **16 bit un-signed integer** format. During normal operation this register will be 0, but if an error occurs some bits in the register will be set resulting in an error code. A description of the different error codes can be found in the chapter *STATUS CODES*, see page 20.

**LcSignal(X)** is a double word (four bytes) constituting a register containing the actual weight signal from load cell **X** in **32 bit signed integer** format. Note that the value is only valid if the corresponding **LcStatus(X)** register is 0 indicating no error present. The resolution of the load cell signal is selectable. Please see below.

Since only status and weight for the load cells are transmitted in the telegram, functions such as status handling, calculation of system weight(s), zeroing and calibration **must** be implemented on the EtherNetIP master. Please refer to the chapter *Data Processing* page 9 for an explanation on how this typically can be done.

### 3) Data Exchange (continued)

#### 3.2 Data formats

The EtherNet/IP communication can transfer data in the following three data formats. Please refer to other literature for further information on these formats as it is outside the scope of this document.

#### 3.3 Unsigned integer format (16 bit)

The following are examples of decimal numbers represented on 16 bit un-signed integer format:

<u>Decimal</u>	<u>Hexadecimal</u>	<u>Binary (MSB first)</u>
0	0x0000	00000000 00000000
1	0x0001	00000000 00000001
2	0x0002	00000000 00000010
200	0x00C8	00000000 11001000
2000	0x07D0	00000111 11010000
20000	0x4E20	01001110 00100000

#### 3.4 Signed integer format (32 bit)

The following are examples of decimal numbers represented on 32 bit signed integer format:

<u>Decimal</u>	<u>Hexadecimal</u>	<u>Binary (MSB first)</u>
-20000000	0xFECED300	11111110 11001110 11010011 00000000
-2000000	0xFFE17B80	11111111 11100001 01111011 10000000
-200000	0xFFFCF2C0	11111111 11111100 11110010 11000000
-20000	0xFFFFB1E0	11111111 11111111 10110001 11100000
-2000	0xFFFFF830	11111111 11111111 11111000 00110000
-200	0xFFFFFFF38	11111111 11111111 11111111 00111000
-2	0xFFFFFFFEE	11111111 11111111 11111111 11111110
-1	0xFFFFFFF	11111111 11111111 11111111 11111111
0	0x00000000	00000000 00000000 00000000 00000000
1	0x00000001	00000000 00000000 00000000 00000001
2	0x00000002	00000000 00000000 00000000 00000010
200	0x000000C8	00000000 00000000 00000000 11001000
2000	0x000007D0	00000000 00000000 00000111 11010000
20000	0x00004E20	00000000 00000000 01001110 00100000
200000	0x00030D40	00000000 00000011 00001101 01000000
2000000	0x001E8480	00000000 00011110 10000100 10000000
20000000	0x01312D00	00000001 00110001 00101101 00000000



### 3) Data Exchange (continued)

#### 3.5 Scaling

By use of a DIP-switch it is possible to select the desired scaling of the weight signals. The scaling of the weight signals on the Ethernet is determined by SW1.1-2 as follows, where the table shows how a given weight is represented on the Ethernet depending on switch settings:

Weight [gram]	SW1.1 = OFF SW1.2 = OFF (1 gram)	SW1.1 = ON SW1.2 = OFF (1/10 gram)	SW1.1 = OFF SW1.2 = ON (1/100 gram)	SW1.1 = ON SW1.2 = ON (10 gram)
1,0	1	10	100	0
123,4	123	1234	12340	12
12341	12341	123410	1234100	1234

#### 3.6 Measurement time

By use of a DIP-switch it is possible to choose between two different measurement times. All load cells are sampled/averaged over a measurement period determined by SW1.3 as follows:

SW1.3	Measurement
OFF	200 ms
ON	20 ms

The hereby found load cell signals (possibly filtered) are used on the Ethernet until new signals are achieved when the next sample period expires.

### 3) Data Exchange (continued)

#### 3.7 Filtering

By use of DIP-switches it is possible to include one of 15 different FIR filters, which will be used to filter the load cell signals. Thus it is possible to send the unfiltered load cell signals achieved over the selected measurement period through one of the following FIR filters, before the results are transmitted on the Ethernet:

SW1.	SW1.5	SW1.6	SW1.6	No.	Taps	Frequency		Damping
						Tavg = 20ms	Tavg = 200ms	
OFF	OFF	OFF	OFF	0	-	-	-	-
ON	OFF	OFF	OFF	1	7	12.0 Hz	1.2 Hz	-60dB
OFF	ON	OFF	OFF	2	9	10.0 Hz	1.0 Hz	-60dB
ON	ON	OFF	OFF	3	9	12.0 Hz	1.2 Hz	-80dB
OFF	OFF	ON	OFF	4	12	8.0 Hz	0.8 Hz	-60dB
ON	OFF	ON	OFF	5	12	10.0 Hz	1.0 Hz	-80dB
OFF	ON	ON	OFF	6	15	8.0 Hz	0.8 Hz	-80dB
ON	ON	ON	OFF	7	17	6.0 Hz	0.6 Hz	-60dB
OFF	OFF	OFF	ON	8	21	6.0 Hz	0.6 Hz	-80dB
ON	OFF	OFF	ON	9	25	4.0 Hz	0.4 Hz	-60dB
OFF	ON	OFF	ON	10	32	4.0 Hz	0.4 Hz	-80dB
ON	ON	OFF	ON	11	50	2.0 Hz	0.2 Hz	-60dB
OFF	OFF	ON	ON	12	64	2.0 Hz	0.2 Hz	-80dB
ON	OFF	ON	ON	13	67	1.5 Hz	0.15 Hz	-60dB
OFF	ON	ON	ON	14	85	1.5 Hz	0.15 Hz	-80dB
ON	ON	ON	ON	15	100	1.0 Hz	0.10 Hz	-60dB

**NOTE:** With all switches OFF no filtering is performed.

## 4) Data Processing

### 4.1 Zeroing, calibration and weight calculation

Calculation of system weight(s) is done by addition of the weight registers for the load cells belonging to the system. This is explained below. **Note** that the result is only valid if all status registers for the load cells in question indicate no errors. It should also be noted that it is up to the master to ensure the usage of consistent load cell data when calculating the system weight (the used data should come from the same telegram).

#### 4.1.1 Zeroing of weighing system

Zeroing of a weighing system (all load cells in the specific system) should be performed as follows, taking into account that no load cell errors may be pre-sent during the zeroing procedure:

- 1) The weighing arrangement should be empty and clean.
- 2) The EtherNetIP master verifies that no load cell errors are present, after which it reads and stores the actual weight signals for the load cells of the actual system in corresponding zeroing registers:

$$\text{LcZero}[x] = \text{LcSignal}[x]$$

- 3) After this the uncalibrated gross weight for load cell X can be calculated as:

$$\text{LcGross}[x] = \text{LcSignal}[x] - \text{LcZero}[x]$$

### 4.2 Corner calibration of weighing system

In systems where the load is not always placed symmetrically the same place (for example a platform weight where the load can be placed randomly on the platform when a weighing is to take place), a fine calibration of a systems corners can be made, so that the weight indicates the same independent of the position of the load. This is done as follows:

- 1) Check that the weighing arrangement is empty. Zero the weighing system.
- 2) Place a known load (CalLoad) directly above the load cell that is to be corner calibrated.
- 3) Calculate the corner calibration factor that should be multiplied on the uncalibrated gross weight of the load cell in order to achieve correct showing as:

$$\text{CornerCalFactor}[x] = (\text{CalLoad}) / (\text{LcGross}[x])$$

After this the determined corner calibration factor is used to calculate the calibrated gross weight of the load cell as follows:

$$\text{LcGrossCal}[x] = \text{CornerCalFactor}[x] * \text{LcGross}[x]$$

## 4) Data Processing (continued)

### 4.3 Calculation of uncalibrated system weight

Based on the load cell gross values (LcGross[x] or LcGrossCal[x]), whether they are corner calibrated or not, an uncalibrated system weight can be calculated as either:

$$\text{Gross} = \text{LcGross}[X1] + \text{LcGross}[X2] + \dots$$

or:

$$\text{Gross} = \text{LcGrossCal}[X1] + \text{LcGrossCal}[X2] + \dots$$

### 4.4 System calibration of weighing system

Based on the uncalibrated system weight a system calibration can be made as follows:

- 1) Check that the weighing arrangement is empty. Zero the weighing system.
- 2) Place a known load (CalLoad) on the weighing arrangement. **NOTE:** In order to achieve a correct calibration of the system it is recommended, that the used calibration load is at least 50% of the system capacity.
- 3) Calculate the calibration factor that should be multiplied on the uncalibrated system weight in order to achieve correct showing as:

$$\text{CalFactor} = (\text{CalLoad}) / (\text{Actual Gross})$$

After this the determined calibration factor is used to calculate the calibrated system weight as follows:

$$\text{GrossCal} = \text{CalFactor} * \text{Gross}$$

If the determined calibration factor falls outside the interval 0.9 to 1.1 it is very likely that there is something wrong with the mechanical part of the system. This does not, however, apply to systems that do not have a load cell under each supporting point. For example on a three legged tank with only one load cell, you should get a calibration factor of approximately 3 because of the two “dummy” legs.

## 5) Installation of system

### 5.1 Checklist during installation

During installation of the system the following should be checked:

1. All hardware connections are made as described below.
2. Connect the TE67X000002150 Ethernet to a PC with a RS232 connection and setup IP Address etc. as describe below.
3. If necessary the EtherNetIP master should be configured to communicate with the TE67X000002150 Ethernet module using the supplied EDS file.
4. Set the scaling/resolution of the weight signal by use of SW1.1-2 as described above.
5. The load cells are mounted mechanically and connected to the TE67X000002150 Ethernet module using their corresponding load cell interface module. The load cell addresses are set using the DIP-switches on the load cell interface modules, so that they forth running from address 0 (0-3).
6. The TE67X000002150 Ethernet module is connected to the EtherNetIP network using the RS45 Ethernet connector in the front panel.
7. Power (24VDC) is applied through the two pole connector (J2). The EtherNetIP communication is started.
8. Verify that the MS lamp and the NS lamp both end up green.
9. Verify that the TxBB lamp (green) on the Ethernet module is lit (after 10 seconds), and that the TxBB lamps on all the load cell interface modules are also lit (can flash slightly).
10. Verify that none of the D1 or D2 lamps are lit.
11. Verify that the TE67X000002150 Ethernet module has found the correct load cells (LcRegister), and that no load cell errors are indicated (LcStatus(x)).
12. Verify that every load cell gives a signal (LcSignal(x)) by placing a load directly above each load cell one after the other (possibly with a known load).

The system is now installed and a zero and fine calibration is made as described earlier. Finally verify that the weighing system(s) returns a value corresponding to a known actual load.

Note that in the above checklist, no consideration has been made on which functions are implemented on the EtherNetIP master.

## 6) Hardware description

### 6.1 TE67X000002150 overview

The following figure is an overview of how a TE67X000002150 Ethernet system is made using four load cell interface modules:

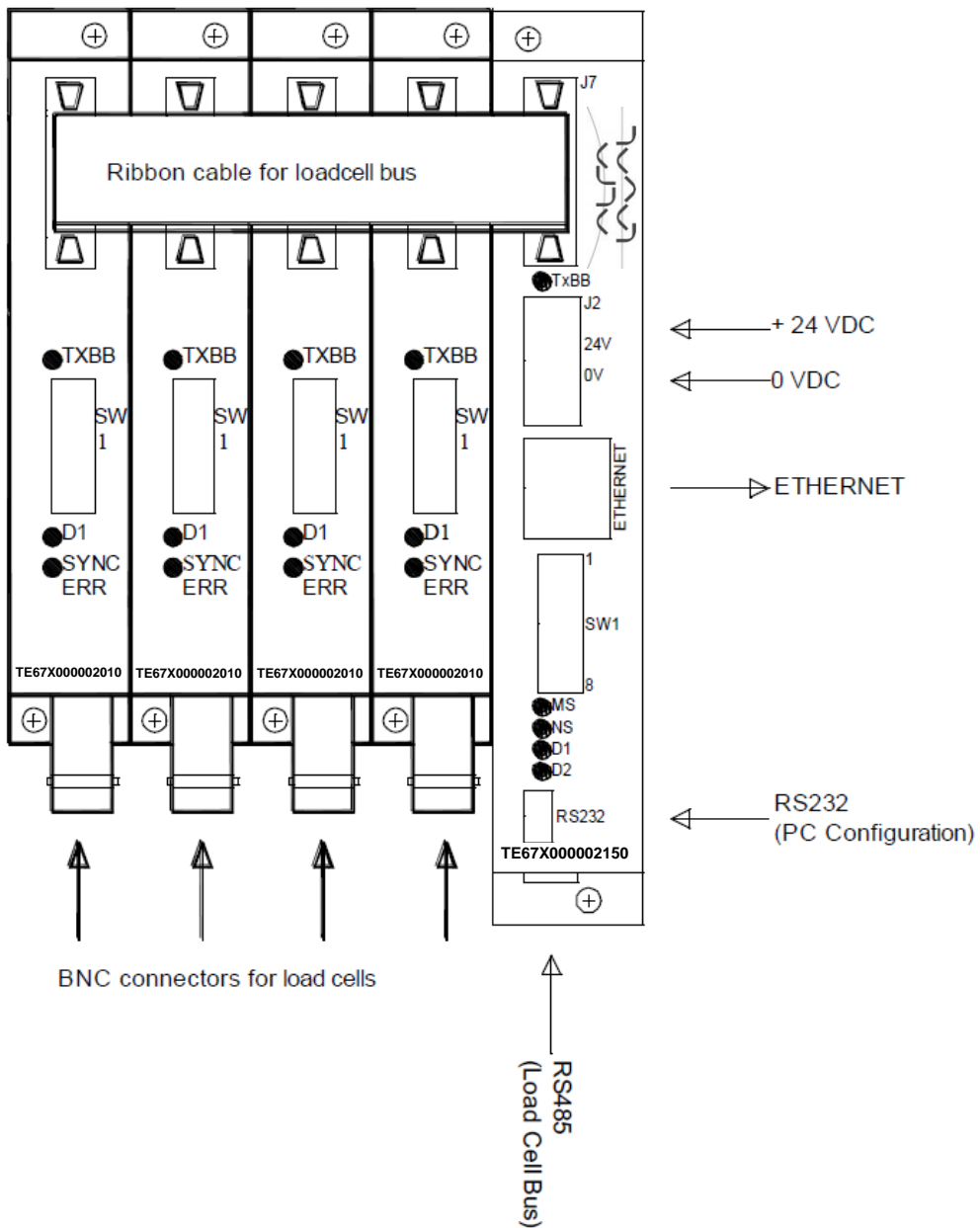

## 6) Hardware description (continued)

### 6.2 Connection of power (J2)

This chapter describes the connection of power supply to the TE67X000002150 Ethernet module.

The TE67X000002150 module is powered by applying +24VDC on the green two pole connector (J2) as specified on the front panel of the TE67X000002150 module. This powers the entire TE67X000002150 system including the load cell interface modules and load cells connected using the supplied ribbon cable described below.

The 2 pole connector (J2) on the TE67X000002150 Ethernet module has these connections:

J2 CONNECTER	FUNCTION
J2.1	+24VDC (Vin)
J2.2	0 VDC (GNDin)

**IMPORTANT:** The used power supply must be stable and free of transients. It may therefore be necessary to use a separate power supply dedicated to the weighing system, and not connected to any other equipment.

### 6.3 Connection of load cells (J7)

This chapter describes the connection of load cells to the TE67X000002150 Ethernet module.

The 10 pole connector (J7) on the TE67X000002150 module is connected to the 10 pole connectors on the load cell interface modules using the supplied ribbon cable with mounted connectors. Through this RS485 bus cable connection of power supply to the individual modules is achieved and data can be transferred from the load cell modules to the TE67X000002150 module.

The 10 pole connector (J7) on the TE67X000002150 Ethernet module has these connections:

J7 CONNECTER	FUNCTION
J7.1 – J7.2	RS485-B (DATA- )
J7.3 – J7.4	RS485-A (DATA+)
J7.5 – J7.6	0 VDC (GNDin)
J7.7 – J7.8	+24VDC (Vin)
J7.9 – J7.10	I/O line

## 6) Hardware description (continued)

### 6.4 RS485 connector (J1)

The green 3 pole connector (J1) at the bottom of the TE67X000002150 Ethernet module contains the same RS485 bus that is available through the ribbon cable connector (J7), which is normally used for interfacing load cells. This allows an alternate way of connecting load cells to the TE67X000002150 module. In other applications where no load cells are connected to the TE67X000002150 module, this connector may be used to interface different equipment to the TE67X000002150 module using RS485 communication.

The 3 pole connector (J1) on the TE67X000002150 Ethernet module has these connections:

J1 CONNECTER	FUNCTION
J1.1	RS485-B (DATA-)
J1.2	RS485-A (DATA+)
J1.3	0 VDC (GNDin)

### 6.5 RS232 connector (J4)

The small 4 pole connector (J4) at the bottom of the TE67X000002150 Ethernet module contains an RS232 communication channel. This RS232 channel is used for setup/configuration of the TE67X000002150 Ethernet module from a PC as described below. Connection to this connector is made using a special serial cable supplied by Alfa Laval Kolding A/S.

The 4 pole connector (J4) on the TE67X000002150 Ethernet module has these connections:

J4 CONNECTER	FUNCTION
J4.1	RS232-GND (connected to PC- GND)
J4.2	RS232-RXD (connected to PC-TXD)
J4.3	RS232-TXD (connected to PC-RXD)
J4.4	RS232-GND (connected to PC- GND)

### 6.6 Ethernet connector (J8)

The front panel of the TE67X000002150 Ethernet module is equipped with a standard Ethernet RJ47 connector for Cat5 cables.



## 6) Hardware description (continued)

### 6.7 DIP-switch settings

The TE67X000002150 Ethernet module is equipped with an 8 pole DIP switch block located in the front of the module named SW1. This DIP switch block has the following function:

<b>SWITCH</b>	<b>FUNCTION</b>
SW1.1-2	<b>Scaling</b> Used to select the desired scaling as described above.
SW1.3	<b>Measurement time</b> Used to select the desired measurement time as described above.
SW1.4-SW1.7	<b>Filtering</b> Used to select the desired filter as described above.
SW1.8	<i>Reserved for future use</i>

The TE67X000002150 Ethernet module is also equipped with an 8 pole DIP switch block located inside the module that is only accessible if the cover is removed. This DIP switch block is named SW2 and has the following function:

<b>SWITCH</b>	<b>FUNCTION</b>
Sw2.1-Sw2.8	<i>Reserved for future use</i>

### 6.8 Light Emitting Diodes (LEDs)

The TE67X000002150 Ethernet module is equipped with a number of status lamps (LEDs) located in the front panel. These have the following functionality:

<b>LED</b>	<b>FUNCTION</b>
TxBB (Green)	<b>TE67X000002150 communication with load cells</b> Ethernet module is communicating with load cells.
Ethernet connector (RJ45) Yellow	<b>Link</b> Ethernet is connected.
Ethernet connector (RJ45) Green	<b>Activity</b> Ethernet data is received or transmitted.
MS (Green/Red)	<b>Module Status LED</b> The TE67X000002150 Module Status LED, that can be lit/flashing in different colors depending on the status of the module. The function of the MS LED is given
NS (Green/Red)	<b>Network Status LED</b> The TE67X000002150 Network Status LED, that can be lit/flashing in different colors depending on the status of the network. The function of the NS LED is given
D1 (Red)	<i>Reserved for future use</i>
D2 (Red)	<i>Reserved for future use</i>

## 6) Hardware description (continued)

### 6.8 Light Emitting Diodes (LEDs)

The MS and NS LED's can in conjunction with the table below be used for error finding.

Light emitting diode	Color	Status	Description
MS	Green	ON	<b>Normal Operation.</b> Communication performed normally.
		Flash-ing	<b>Standby State.</b> The module needs supervision.
	Red	ON	<b>Unrecoverable fault.</b> A timer error, memory error or other system error. The module may need replacing.
		Flash-ing	<b>Recoverable fault.</b> Configuration error, DIP-switch not set correct, IP-Address error or similar error. Correct error and restart module.
	---	OFF	<b>No power.</b> The power is disconnected or the module is being restarted.
NS	Green	ON	<b>On-Line, Connection OK.</b> The module is On-Line and a connection with the master has been established.
		Flash-ing	<b>On-Line, No Connection.</b> The module is On-Line but no connection to the master has been established.
	Red	ON	<b>Critical Communication Error.</b> The module has detected an error that makes it impossible to communicate on the network.
		Flash-ing	<b>Communication Time-Out.</b> One or more I/O connections are in the Time-Out state.
	---	OFF	<b>No power/Off-line.</b> The device may not be powered.

## 6) Hardware description (continued)

### 6.8 Light Emitting Diodes (LEDs)

The TE67X000002150 Ethernet module is also equipped with a number of status lamps (LEDs) located inside the module and are only visible if the cover is removed. These have the following functionality:

<b>SWITCH</b>	<b>FUNCTION</b>
D4 (Yellow)	<b>RS485 RX</b> RS485 data is received.
D9 (Green)	<b>RS485 TX</b> RS485 data is transmitted.
D14 (Yellow)	<b>RS232 RX</b> RS232 data is received.
D5 (Green)	<b>RS232 TX</b> RS232 data is transmitted.
D10 (Red)	<b>Power</b> 3.3 VDC internal power supply is on.

### 6.9 Hardware Self-test

During power-on the TE67X000002150 Ethernet module will perform a hardware self-test. The test will cause the light emitting diodes D2, MS and NS to flash shortly one at a time.

### 6.10 Update times

The TE67X000002150 Ethernet module samples the load cell signals over a period of 200 mS. The hereby found load cell signals are used in the EtherNetIP communication until new signals are achieved when the next sample period expires. Update times across the EtherNetIP communication depends on the specific EtherNetIP configuration (switches, number of units, master scan times etc.) and are beyond the scope of this document.

## **7) Maintenance, Service / Repair & Warranty**

### **7.1 Maintenance**

This device is maintenance-free, but to ensure optimum accuracy of the weighing installation it is recommended to inspect the weighing system installation at regular intervals.

Recommended inspection points are:

1: Verify that tank is freestanding. Are all pipe connections flexible and not restraining vertical movement of the tank?

1a: Verify that no changes have been done to the tank? If any modifications have been performed ensure that they are done correctly according to installation recommendations for weighing systems.

2: Verify that all legs of the tanks all are in physical contact with load cells.

### **7.2 Service / Repair**

#### **7.2.1 Return**

Upon every return of the device, no matter if for recalibration, modifications or repair, it is necessary to contact your local Alfa Laval office to guarantee a quick execution of your request.

Please inform us by sending an email to: [Alteq.PartsandService@alfalaval.com](mailto:Alteq.PartsandService@alfalaval.com). Include the number of devices sent and request a Return Number. Afterwards clean the device, pack it shatterproof and send it to Alfa Laval Kolding A/S indicating the Return Number.

### **7.3 Warranty conditions**

The warranty conditions are subject to the legal warranty period of 12 months from the date of delivery. In case of improper use, modifications of or damages to the device, we do not accept warranty claims. Damaged diaphragms will also not be accepted. Furthermore, defects due to normal wear are not subject to warranty services.

## 8) How to contact Alfa Laval Tank Equipment

For further information please feel free to contact:

### **Alfa Laval Tank Equipment**

#### **Alfa Laval Kolding A/S**

31, Albuen – DK 6000 Kolding – Denmark

Registration number: 30938011

Tel switchboard: +45 79 32 22 00 – Fax switchboard: +45 79 32 25 80

[www.toftejorg.com](http://www.toftejorg.com), [www.alfalaval.dk](http://www.alfalaval.dk) – [info.dk@alfalaval.com](mailto:info.dk@alfalaval.com)

Contact details for all countries are continually updated on our websites.

## 9) Appendices

### 9.1 Appendix A – Status Codes

Status codes are shown as a 4 digit hex number. If more than one error condition is present the error codes are OR'ed together.

CODE (Hex)	CAUSE
0001	<b>Invalid/missing 'sample' ID</b> Bad connection between TE67X000002029 analog module and load cell module.
0002	<b>Load cell timeout</b> Bad connection between load cell and load cell module.
0004	<b>Load cell not synchronized</b> Bad connection between load cell and load cell module.
0008	<b>Hardware synchronization error</b> Cable between load cell modules shorted or disconnected.
0010	<b>Power failure</b> Supply voltage to load cells is too low.
0020	<b>Overflow in weight calculation</b> Internal error in load cell module.
0026	<b>No communication to a load cell</b> <ul style="list-style-type: none"> <li>• Wrongly mounted BNC-connector</li> <li>• Defect cable</li> <li>• Defect 2010 module</li> <li>• Defect load cell</li> </ul>
0040	<b>Invalid/missing 'latch' ID</b> Bad connection between TE67X000002029 analog module and load cell module.
0080	<b>No answer from load cell module</b> No data is received from load cell module. This can be caused by the removal of a load cell module, no power to the module or that the connection between load cell module and TE67X000002029 analog module is broken.
0100	<i>Reserved for future use</i>
0200	<i>Reserved for future use</i>
0400	<i>Reserved for future use</i>
0800	<b>No load cell modules answer</b> Bad connection between TE67X000002029 analog module and load cell module. Not all telegrams from TE67X000002029 analog module are received in load cell module.
1000	<i>Reserved for future use</i>
2000	<i>Reserved for future use</i>
4000	<i>Reserved for future use</i>
8000	<b>Wrong number of load cells</b> The expected number of load cells found during power-on does not match the number indicated by the "n.Lc." parameter. If the "n.Lc." parameter setting is correct, it must be examined that all load cell module addresses are correct.

## 9) Appendices (continued)

### 9.2 Appendix B – Setup with Terminal Interface

The MAC address of the module is preset to a unique value within the Alfa Laval Kolding A/S range. The default settings for IP address etc. are

DHCP:	Disabled
IP Address:	192.168.1.199
Subnet mask:	255.255.255.0
Gateway:	192.168.1.254

These defaults can be altered by connecting the RS232 connector (J4) to a COM port on a PC and starting a terminal emulation program (like Hyper- Terminal or RealTerm) with these settings:

When the TE67X000002150 is powered the following will be displayed

```
Alfa Laval Kolding A/S
TE67X000002150 module.
Software version: EthernetIP.111025.1.1
```

```
-----
--- MAIN MENU
(1) show Info
(2) change Settings
(3) reset and switch to Download mode
(4) show LC signals
-----
```

## 9) Appendices (continued)

### 9.2 Appendix B – Setup with Terminal Interface

#### 9.2.1 IP Address setting

To get the main menu press “Enter” one or more times until the main menu is displayed:

```
-----  
--- MAIN MENU (1) show Info  
  (2) change Settings  
  (3) reset and switch to Download mode  
  (4) show LC signals  
-----
```

Then press “2” to the *Change Settings Menu* displayed:

```
-----  
--- CHANGE SETTINGS MENU (1) change Mac address  
  (2) select enable of Dhcp  
  (3) change Ip address  
  (4) change Subnet mask  
  (5) change Gateway address  
  (6) Return to Main Menu  
-----
```

Then press “3” to change to entry of a new IP address. The display will be like this:

```
*****  
*** ENTER NEW IP ADDRESS:  
Enter IP address in decimal (ddd.ddd.ddd.ddd) and press 'Enter':
```

Now enter a new IP address (e.g. 192.168.1.109) and press enter. Change the Subnet Mask and the Gateway Address the same way if necessary. **DO NOT** change the factory set MAC address. Do not enable DHCP if a DHCP server is not present.



## 9) Appendices (continued)

### 9.2 Appendix B – Setup with Terminal Interface

#### 9.2.1 IP Address setting

To check all settings re-power the device and in the Main Menu press “1” to select the System Info display looking like this

```
*****  
*** SYSTEM INFO:  
MAC Address: 00 50 c2 c5 30 10  
Use DHCP: No (use statically assigned addresses - see below)  
IP Address: 192.168.1.109  
Subnet Mask: 255.255.255.0  
Gateway IP: 192.168.1.254
```

Check that all settings are as expected. The device is now ready to connect to the EtherNetIP network

## 9) Appendices (continued)

### 9.2 Appendix B – Setup with Terminal Interface

#### 9.2.2 Load cell signals

To get the main menu press “Enter” one or more times until the main menu is displayed:

```
-----  
--- MAIN MENU  
(1) show Info  
(2) change Settings  
(3) reset and switch to Download mode  
(4) show LC signals  
-----
```

Then press “4” to start showing the load cell signals like this:

```
-----  
--- LC signals:  
0000,    -22868;0000,    -23281;0000,    -24449;0000,    -8216  
0000,    -22871;0000,    -23277;0000,    -24448;0000,    -8215  
0000,    -22868;0000,    -23279;0000,    -24450;0000,    -8216  
0000,    -22871;0000,    -23280;0000,    -24451;0000,    -8215  
0000,    -22864;0000,    -23280;0000,    -24448;0000,    -8215
```

Each line will contain the load cell status followed by the load cell signal for each load cell. These line will be shown continuously until stopped. To stop display of load cell signals press “4”, “Enter” or “Esc” in order to return to the *Main Menu* looking like this:

```
-----  
--- MAIN MENU  
(1) show Info  
(2) change Settings  
(3) reset and switch to Download mode  
(4) show LC signals  
-----
```

## 9) Appendices (continued)

### 9.3 Appendix C – Allen Bradley connection

To connect the module to an Allen Bradley (Rockwell Automation) PLC using the Logix 5000 software the following must be observed:

1. Use the "ETHERNET MODULE Generic Ethernet Module
2. Set connection format to "SINT"
3. Set "Input" "Assembly instance to 103, "Size" 26 (8-bit)
4. Set "Output" "Assembly instance to 102, "Size" 2 (8-bit)
5. Set "Configuration" "Assembly instance to 101, "Size" 1 (8-bit)

### 9.4 Appendix D – Omron connection

The supplied EDS file can be used in the Omron configurator.

**But please beware** that the terms "input" and "output" may be confusing in the Omron configurator. These terms are always from the PLC's point of view. So the data from the TE67X000002150 module to the PLC is referred to as "input" even though it is actually an output from the TE67X000002150.

The data from the TE67X000002150 module is found the input assembly 103.

The output and the confirmation assemblies (101 and 102) are not used.

## 9) Appendices (continued)

### 9.5 Appendix E – Download of new software

It is possible to download new software to the TE67X000002150 Ethernet module by connecting the RS232 connector (J4) to a COM port on a PC, and then using a terminal emulation program as well as the “Flash Loader Demonstrator” program from STMicroelectronics. The step-by-step procedure for downloading new software to the TE67X000002150 Ethernet module is described in the following.

#### 9.5.1 Download procedure

- 1) The RS232 connector (J4) on the TE67X000002150 module is connected to a COM port on a PC.
- 2) A terminal emulation program (like HyperTerminal or RealTerm) is started and the serial settings are set to:

Baudrate:	9600
Databits:	7
Parity:	Even
Stopbits:	1
Flow control:	None

- 3) When the TE67X000002150 is powered the following will be displayed (or press “Enter” one or more times until the main menu is displayed):

```
Alfa Laval Kolding A/S
TE67X000002150 module.
Software version: EthernetIP.111025.1.1
```

```
-----
--- MAIN MENU
(1) show Info
(2) change Settings
(3) reset and switch to Download mode
(4) show LC signals
-----
```

- 4) Then press “3” to reset the module and switch to Download mode causing the following to be displayed:

```
Now ressetting for download. Close program and start Flash Loader
```

- 5) Without pressing any keys close down the terminal program while leaving the TE67X000002150 module powered and connected to the PC.
- 6) Start the “Flash Loader Demonstrator” program from STMicroelectronics. If the program has not yet been installed on the PC, install it by running the supplied “Flash\_Loader\_Demonstrator\_v2.2.0\_Setup.exe” file and following the standard installation instructions.

## 9) Appendices (continued)

### 9.5.1 Download procedure

7) Once the “Flash Loader Demonstrator” is started, the following screen should appear:

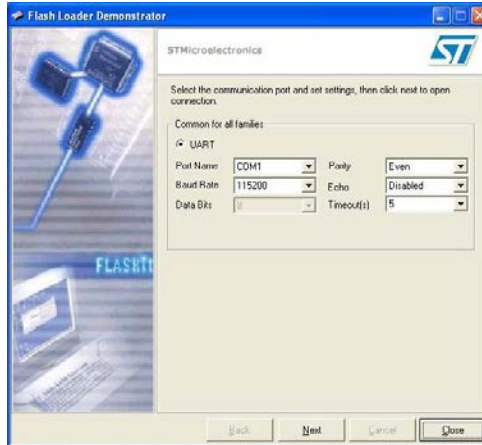

8) Click the “Next” button to open the connection. Once the connection is established, the following screen will appear:

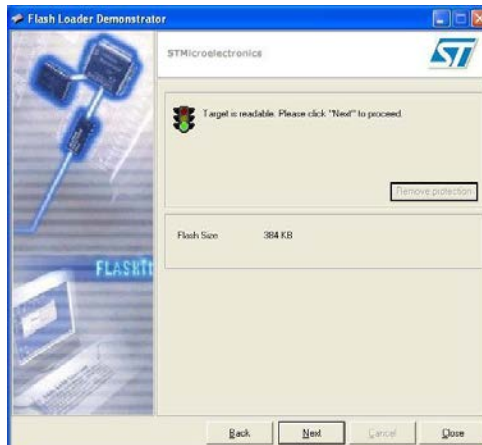

9) Click the “Next” button to proceed and the following screen will appear:

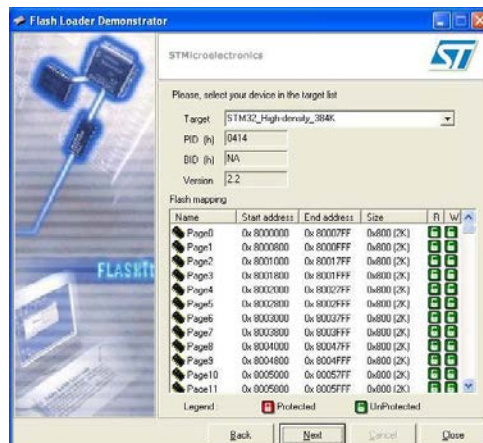

## 9) Appendices (continued)

### 9.5.1 Download procedure

- 10) Ensure target indicates “STM32\_High-density\_384K” and click the “Next” button to proceed causing the following screen to appear:

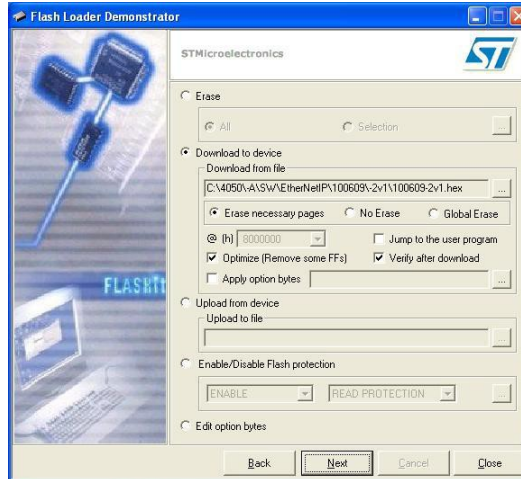

- 11) Select “Erase” and ensure “All” is selected. Perform an erase of the original program by clicking the “Next” button. Once the erase operation has been completed the following screen will appear:

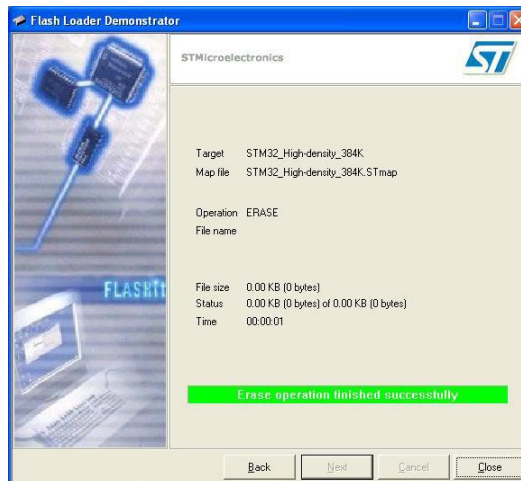

## 9) Appendices (continued)

### 9.5.1 Download procedure

- 12) Click the “Back” button in order to return to the following screen where the “Erase” option was selected:

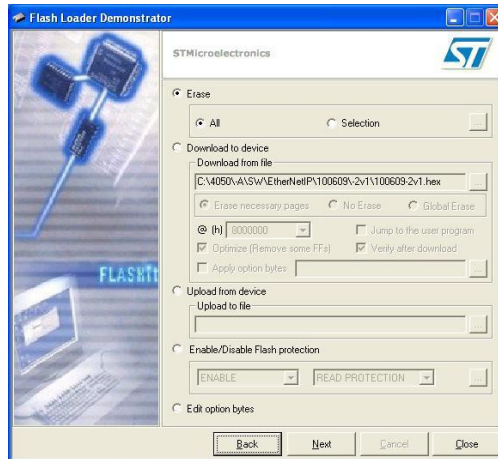

- 13) Now select “Download to device” and click the “...” button and use the new file selection window to select the desired hex file to be downloaded. Select “Erase necessary pages” so the window appears as follows:

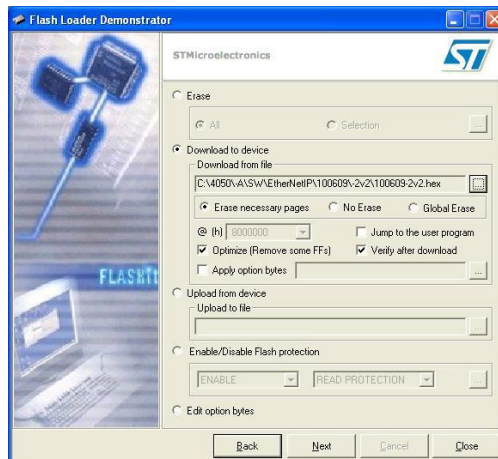

## 9) Appendices (continued)

### 9.5.1 Download procedure

- 14) Click the “Next” button to start the download and verify process. Once the download and verify process has been completed the screen will appear as follows:

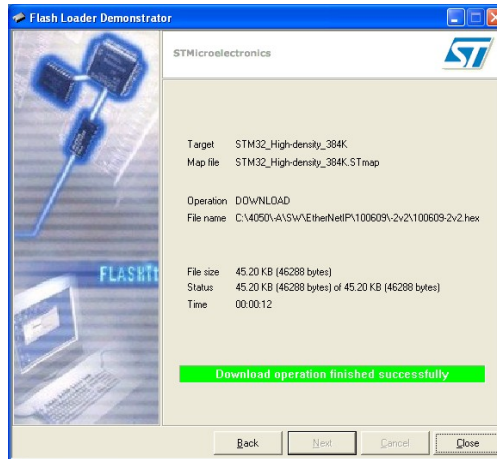

- 15) Click the “Close” button to terminate the “Flash Loader Demonstrator” program.
- 16) Remove power from the TE67X000002150 module.
- 17) Start the terminal emulation program again with the same settings as specified in 2).
- 18) Apply power to the TE67X000002150 module and verify that the indicated program ID appearing in the terminal program matches the new program that has been downloaded.



## 10) EC Declaration of conformity



EC Declaration of Conformity

The designated company

Alfa Laval Kolding A/S  
Company name

Albuen 31, 6000 Kolding, Denmark  
Address

+ +45 79 32 22 00  
Phone no.

hereby declare that

<u>Alfa Laval Ethernet module</u> Denomination	<u>TE67X000002150</u> Type
---	-------------------------------

*valid for serial numbers from 2014-00001 and subsequent serial numbers.*

is in conformity with the provisions of the Directive 73/23/EEC appendix IIIB and directive 89/356/EEC.

And furthermore declares that the following (parts/clauses of) applicable directives have been used:

- EN 61010 Part 1 (Safety requirements for electrical equipment for measurements control and laboratory use)
- EN 60529 (degrees of protection provided by enclosures)
- EN50081 part 1 (EMC, generic emission standard)
- 50082 part 2 (EMC, generic immunity standard)

The technical construction file for this instrument is retained at the above address.

<u>R&amp;D Manager</u> Title	<u>Henrik Falster Hansen</u> Name	 Signature
---------------------------------	--------------------------------------	--

<u>August 19, 2014</u> Date	<u>Alfa Laval Kolding A/S</u> Company
--------------------------------	--



**How to contact Alfa Laval**

Contact details for all countries are continually updated on our website.

Please visit [www.alfalaval.com](http://www.alfalaval.com) to access the information directly.

© Alfa Laval Corporate AB

This document and its contents is owned by Alfa Laval Corporate AB and protected by laws governing intellectual property and thereto related rights. It is the responsibility of the user of this document to comply with all applicable intellectual property laws. Without limiting any rights related to this document, no part of this document may be copied, reproduced or transmitted in any form or by any means (electronic, mechanical, photocopying, recording, or otherwise), or for any purpose, without the expressed permission of Alfa Laval Corporate AB. Alfa Laval Corporate AB will enforce its rights related to this document to the fullest extent of the law, including the seeking of criminal prosecution.