



Instruction manual for 5024 Weighing Terminal

Basic system with Analog output, Ethernet connectivity and Profibus or DeviceNet connectivity. Article no. TE67X000005024

IM-TE91K012-EN3
ESE02163EN

Date of issue: September 9, 2014
First published: November 2011

Original manual

1) Contents

1) Contents	1
2) Operation.....	3
2.1 Introduction.....	3
2.2 Power-up sequence.....	4
2.2.1 Zeroing during power up.....	4
2.3 Operator panel.....	4
2.4 Menus.....	5
2.5 Screens overview	5
2.6 Data entry	5
2.6.1 Entry using selection list	6
2.6.2 Entry of numbers	7
3) Screens	10
3.1 Normal display	10
3.2 New batch.....	11
3.3 Registrations.....	11
3.3.1 Registration menu.....	12
3.3.2 Delete batch	12
3.4 System Information.....	13
3.5 System settings	14
3.6 Loadcell status.....	14
3.7 Service mode.....	15
3.7.1 Setting date and time.....	16
3.8 System.....	16
3.9 Weighing.....	17
3.9.1 Weighing range modes.....	18
3.9.2 Configuring weighing ranges	18
3.10 Loadcell parameters	18
3.10.1 Loadcell type	19
3.10.2 Number of loadcells	19
3.10.3 Number of supports	19
3.11 Coarsetare.....	20
3.11.1 Performing coarsetare	20
3.12 Zeroing	21
3.13 Calibration	21
3.13.1 Calibration factor.....	22
3.13.2 Calibration load.....	22
3.13.3 Perform calibration.....	22
3.14 Weight display	23
3.14.1 Interval.....	24
3.14.2 Filters.....	24
3.15 Analog output	24
3.15.1 Output type	25
3.15.2 Output value	25
3.15.3 Full-scale value.....	25
3.15.4 Error output value	25
3.15.5 Test output.....	25
3.16 Ethernet	25
3.17 External module.....	25
4) Ethernet communication.....	26
4.1 Ethernet specification	26
4.1.1 Registration	26
4.1.2 PC Test software	26
4.2 Ethernet.....	26
4.2.1 Ethernet settings.....	27
4.3 Ethernet Protocols	27
4.3.1 Ethernet protocol settings	27

5) External modules.....	28
5.1 Introduction.....	28
5.2 External module.....	28
5.3 External module data.....	29
5.4 External communication using PPO.....	31
5.5 MOD.....	31
5.5.1 MDS.....	31
5.6 PCV Description.....	32
5.6.1 PCA.....	32
5.6.2 PNU.....	32
5.6.3 PVA.....	32
5.7 PCD Description.....	33
5.7.1 CTW/STW.....	34
5.7.2 MRV/MAV.....	34
5.8 Communication overview.....	34
5.9 RS –Reference Value Selector, MRV – Main Reference value.....	34
5.10 AS –Actual Value Selector, MAV – Main Actual value.....	34
5.11 CTW –Control Word.....	34
5.12 STW –Status Word.....	35
5.13 Parameters.....	35
6) Hardware description.....	36
6.1 Rear view.....	36
6.2 Connection of power.....	36
6.3 Loadcell connection.....	37
6.4 Digital I/O connector.....	37
6.5 RS485 communication connector (Profibus).....	37
6.6 Analog output connector.....	37
6.7 Ethernet connector.....	37
6.8 Jumper settings.....	38
6.9 Light Emitting Diodes (LEDs).....	38
6.10 MCE2035 Profibus module.....	38
6.10.1 Profibus DP specification.....	38
6.10.2 Checklist during installation.....	39
6.10.3 2035 Connection.....	39
6.10.4 DIP-switch settings.....	39
6.10.5 Light Emitting Diodes.....	40
6.10.6 PROFIBUS-DP connector.....	40
6.10.7 Jumpers.....	40
6.10.8 2035 Hardware Selftest.....	41
6.11 MCE9637 Profibus module.....	42
6.11.1 DeviceNet specification.....	42
6.11.2 Checklist during installation.....	42
6.11.3 DIP-switch settings.....	42
6.11.4 Jumpers.....	43
6.11.5 Light Emitting Diodes.....	44
6.11.6 EE-bus connector.....	45
6.12 DeviceNet connector.....	45
7) Appendices.....	46
7.1 Appendix A: Filters.....	46
7.1.1 Sampling filter.....	46
7.1.2 Display filter.....	47
8) How to contact Alfa Laval Tank Equipment.....	48
9) EC Declaration of Conformity.....	49

2) Operation

2.1 Introduction

This document is an overview of the 5024 Weighing Terminal from Alfa Laval Kolding A/S. With the software version stated on the front page the system has an Analog output, Ethernet and Profibus or DeviceNet Connectivity.

The system is operated by a series of screens, menus and selections lists.

© Alfa Laval Corporate AB

This document and its contents is owned by Alfa Laval Corporate AB and protected by laws governing intellectual property and thereto related rights. It is the responsibility of the user of this document to comply with all applicable intellectual property laws. Without limiting any rights related to this document, no part of this document may be copied, reproduced or transmitted in any form or by any means (electronic, mechanical, photocopying, recording, or otherwise), or for any purpose, without the expressed permission of Alfa Laval Corporate AB. Alfa Laval Corporate AB will enforce its rights related to this document to the fullest extent of the law, including the seeking of criminal prosecution.

Note: The illustrations and specifications contained in this manual were effective at the date of printing. However, as continuous improvements are our policy, we reserve the right to alter or modify any unit specification on any product without prior notice or any obligation.

2.2 Power-up sequence

When power is applied to the system, the following steps will be performed:







- The display will show the logo for 5 seconds.
- The display will show its program identification (software name, date and revision).
- The weighing terminal is ready and enters the **NORMAL** screen.

2.2.1 Zeroing during power up

If a zeroing is to be performed during power up (with extended zeroing range), **>0<** must be pressed while the program identification (software name, date and revision) is shown. Pressing **>0<** before this is ignored.

2.3 Operator panel

The operator panel holds a keyboard and a LCD display. The display will show the actual state of the controller and the user entries possible. Below the display seven keys are located. The function of these keys depends on the actual screen selected. The function of the key will always be shown directly above the key. Normally the keys are used to switch between the different screens or to initiate other user actions. Depending on the actual screen the following keys can be used:

<p>F</p>    <p>Clr Print</p> <p>T </p> <p>>0< </p> 	<p>Selects a menu depending on the actual screen.</p> <p>Increases a value or moves cursor up in a menu.</p> <p>Decreases a value or moves cursor down in a menu.</p> <p>Selects entry or accept of a value, or selects an action from a menu.</p> <p>Return to previous screen. Exits menu without action. Clears entered digit.</p> <p>Autotare scale (set net weight to zero).</p> <p>Zero scale (set gross weight to zero).</p>
---	---

The functions stated above are the general function of the keys. Below the specific use of each key will be described depending on the actual screen.

2.4 Menus

Menus are selected by pressing **F**. When a menu is active the current item is changed by **↑** and **↓**, and the item action is selected by pressing **↵**. The menu can be exited without any action by pressing **Clr** or by selecting the "Exit menu" menu item. Above each key is an icon illustrating the actual function for the key in the different screens.

2.5 Screens overview

The system has the following screens, which are selected using the menu system:

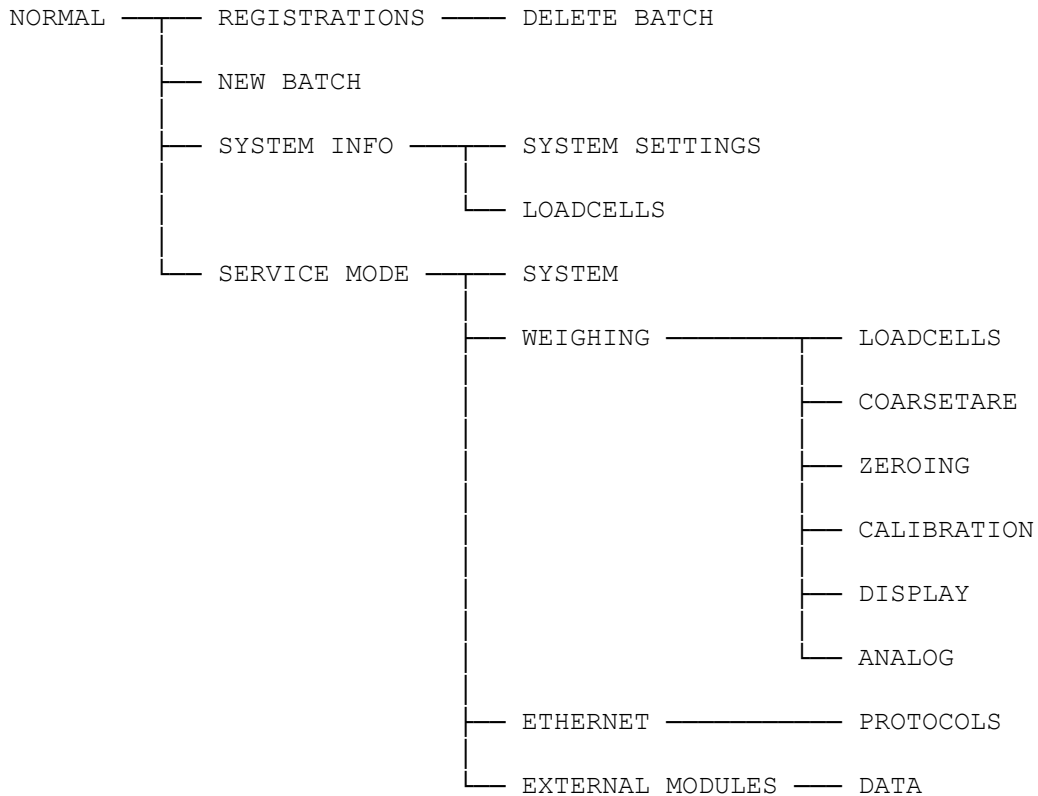

During normal use it is only necessary to use the **NORMAL** screen. The other screens are used during installation and calibration and registration check.

2.6 Data entry







The following chapter describes how data are entered using the keyboard on the weighing terminal. There are two main ways to enter data from the keyboard. Data can be entered by selecting the desired value from a selection list of predetermined values. Data can also be entered by entering the desired value using a data entry screen. The layout of this data entry screen may vary depending on the actual parameter to be entered.

2.6.1 Entry using selection list



Some parameters (such as resolution and decimal point position of the weighing range) are entered using a selection list. When change of this type of parameter is requested, a special pull-down menu will appear with a list of predetermined (allowed) values as shown:





The keys can be used as follows:

- | | |
|---|---|
| <p>F</p> <p></p> <p></p> <p></p> <p>Clr
Print</p> <p></p> <p>T</p> <p></p> <p></p> | <p>Moves the cursor down in this selection list.</p> <p>Moves the cursor up in this selection list.</p> <p>Moves the cursor down in this selection list.</p> <p>Accepts the selected/marked value as the new desired value.</p> <p>Aborts the entry without change of parameter. This can also be done by selecting the "CANCEL" entry form the selection list.</p> <p>Not used.</p> <p>Not used.</p> |
|---|---|

Example - Changing resolution from 0.050 to 0.010:

The screen shown above appears once change of resolution is requested from the **SETUP WEIGHING** screen by moving the cursor using  and  so the "Resolution" parameter is selected and then pressing . In order to change the "Resolution" parameter to 0.010 perform the following:

- | | |
|--|---|
| <p> or </p> <p></p> | <p>Press repeatedly until "0.010" is selected in the selection list.</p> <p>Press to accept selection.</p> |
|--|---|

2.6.2 Entry of numbers

Some parameters (such as minimum and maximum weight of the weighing range) are entered using a data entry screen. When change of this type of parameter is requested, a data entry screen will appear. Please note the layout of the data entry screen may vary slightly depending on the actual parameter to be changed. The data entry screen could look as shown:

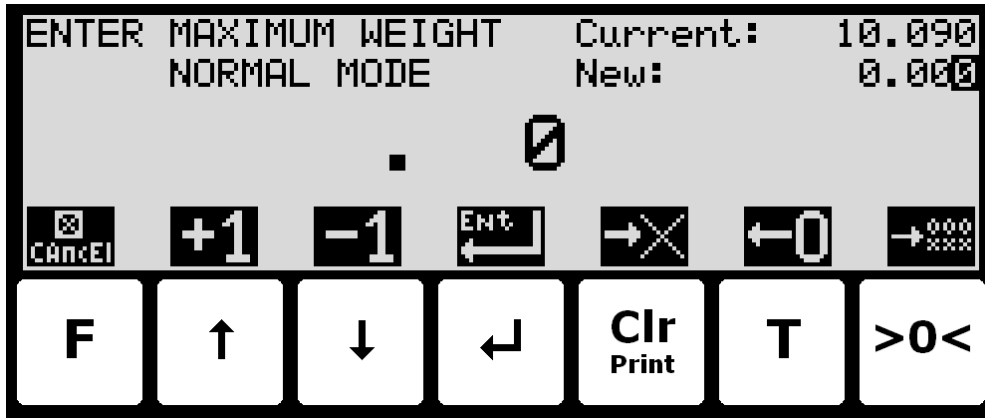



The actual parameter changed is indicated in the upper left part of the display. The current parameter value and the currently entered value is shown in the upper right part of the display. The currently entered value is also shown in the middle of the display in large font.

The keys can be used as follows:



- F** Aborts the entry without change of parameter.
- Increases the value of the digit currently being entered (digit to the right).
- Decreases the value of the digit currently being entered (digit to the right).
- Accepts the entered value as the new desired value.
- Clr** Deletes most right digit and moves all remaining digits one position to the right.
- T** Moves digits one position to the left and inserts a zero on the most right position. This new digit can subsequently be changed using and .
- >0<** Clears all entered digits setting them to zero as if the data entry screen has just been entered.

When entering a value the digits are entered left to right. This means that leftmost digit is entered first. The active digit is changed by and . When the correct value is entered press **T** to advance to the next digit. If an error is made, press to return to the previous digit. When the complete value is entered press to accept it. To abort without any changes press **F**.



Example - Changing maximum weight from 10.000 to 10.090:

The screen shown above appears once change of maximum weight is requested from the **SETUP WEIGHING** screen by moving the cursor using  and  so the "Maximum" weight parameter is selected and then pressing .

In order to change the "Maximum" weight parameter to 10.090 perform the following:

	Press once until	" . 1" is shown in the display.
T	Press three times until	" 1.000" is shown in the display.
	Press once until	" 1.009" is shown in the display.
T	Press once until	" 10.090" is shown in the display.
	Press to accept	" 10.090" as the new desired value.



Example - Changing minimum weight from -1.000 to -0.090:

A similar screen to the screen shown above appears once change of minimum weight is requested from the **SETUP WEIGHING** screen by moving the cursor using  and  so the "Minimum" weight parameter is selected and then pressing .



In order to change the "Minimum" weight parameter to -0.090 perform the following:

	Press once until	"- . 9" is shown in the display.
T	Press once until	"- . 90" is shown in the display.
	Press to accept	"- 0.090" as the new desired value.



Example - Changing date to 11.06.01:

A similar screen to the screen shown above appears once change of date (YY.MM.DD) is requested from the **SETUP MENU** by moving the cursor using  and  so the "SET DATE" entry is selected and then pressing .





The layout of the data entry screen is a bit different as date is entered with two decimal points. In order to change the date (YY.MM.DD) to 11.06.01 perform the following:

T	Press once until	" . .10" is shown in the display.
	Press once until	" . .11" is shown in the display.
T	Press two times until	" .11.01" is shown in the display.
	Press four times until	" .11.06" is shown in the display.
T	Press two times until	"11.06.01" is shown in the display.
	Press to accept	"11.06.01" as the new desired value.



Example - Changing time to 23:45:00:

A similar screen to the screen shown above appears once change of time (HH:MM:SS) is requested from the **SETUP MENU** by moving the cursor using  and  so the "SET TIME" entry is selected and then pressing . The layout of the data entry screen is a bit different as time is entered with two colons.

In order to change the time (HH:MM:SS) to 23:45:00 perform the following:

	Press two times until	" : : 2" is shown in the display.
T	Press once until	" : :20" is shown in the display.
	Press three times until	" : :23" is shown in the display.
T	Press once until	" : 2:30" is shown in the display.
	Press four times until	" : 2:34" is shown in the display.
T	Press once until	" :23:40" is shown in the display.
	Press five times until	" :23:45" is shown in the display.
	Press to accept	"23:45:00" as the new desired value.











Example – Entry of IP address 192.168.001.199:

A similar screen to the screen shown above appears once change of IP address is requested from the **SET-UP ETHERNET** screen by moving the cursor using  and  so the "IP" parameter is selected and then pressing . The layout of the data entry screen is a bit different as IP address is entered with three decimal points.

Please note: Subnet is entered in same way as IP address.

Please note: Due to IP address and subnet requirements not all values are allowed.

In order to change the IP address parameter to 192.168.001.199 perform the following:

	Press once until	" . . . 1" is shown in the display.
T	Press once until	" . . . 10" is shown in the display.
	Press once until	" . . . 19" is shown in the display.
T	Press once until	" . . .190" is shown in the display.
	Press two times until	" . . .192" is shown in the display.
T	Press once until	" . . 1.920" is shown in the display.
	Press once until	" . . 1.921" is shown in the display.
T	Press once until	" . . 19.210" is shown in the display.
	Press four times until	" . . 19.216" is shown in the display.
T	Press once until	" . .192.160" is shown in the display.
	Press two times until	" . .192.168" is shown in the display.
T	Press three times until	" .192.168.000" is shown in the display.
	Press once until	" .192.168.001" is shown in the display.
T	Press once until	" 1.921.680.010" is shown in the display.
	Press once until	" 1.921.680.011" is shown in the display.
T	Press once until	" 19.216.800.110" is shown in the display.
	Press once until	" 19.216.800.119" is shown in the display.
T	Press once until	"192.168.001.190" is shown in the display.
	Press once until	"192.168.001.199" is shown in the display.
	Press to accept	"192.168.001.199" as the new desired value.



3) Screens

The following is a description of each available screen and the active keys in each screen.

3.1 Normal display

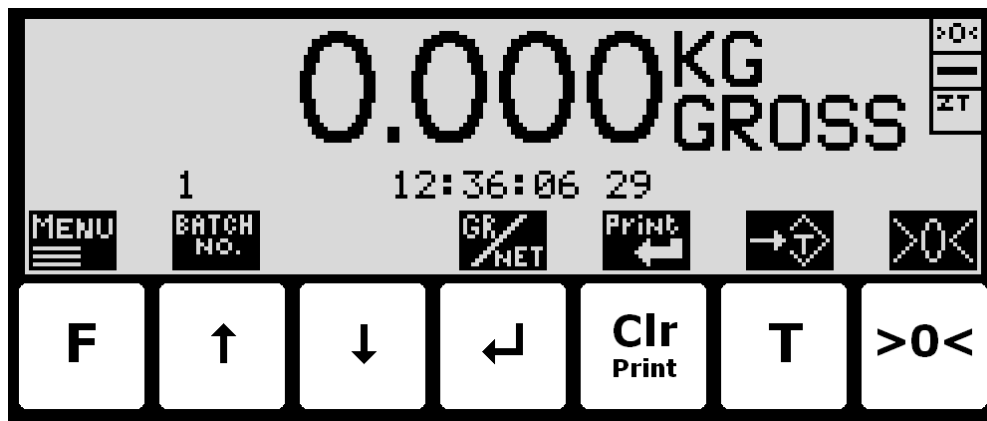





Below the **NORMAL** screen is shown along with the keys that are enabled.



In this screen the actual weight is shown with large types. To the right the unit is indicated and whether the gross or net weight is shown. If the load is above the weighing range the display will show **MAX**. If the load is below the weighing range the display will show **MIN**. If an error is present an error code will be shown (-**XXXX**-) instead of the weight reading. Above  the actual batch number is shown. Above  the actual registration number is shown. In the upper right corner three symbols may be shown below each other indicating:

- '>0<' if the weight is zero (within $0 \pm \frac{1}{4}$ division).
- '—' if the weight reading is steady, or '~' if the weight reading is not steady.
- 'ZT' if automatic zeroing (zero tracking) is active (within $0 \pm \frac{1}{2}$ division).

The keys are used as follows:

-  Selects the **MAIN** menu.
-  Selects the **NEW BATCH** screen to increment the batch number.
-  Not used.
-  Toggles between gross and net reading.
-  Perform a registration.
-  Zeroes the net reading and net reading is selected.
-  Zeroes the gross reading and gross reading is selected.

3.2 New batch

Below the **NEW BATCH** screen is shown:



The keys are used as follows:

F	Not used.
↑	Not used.
↓	Not used.
←	Increments the batchnumber.
Clr	Not used.
T	Not used.
>0<	Returns to the NORMAL screen without incrementing the batch number.

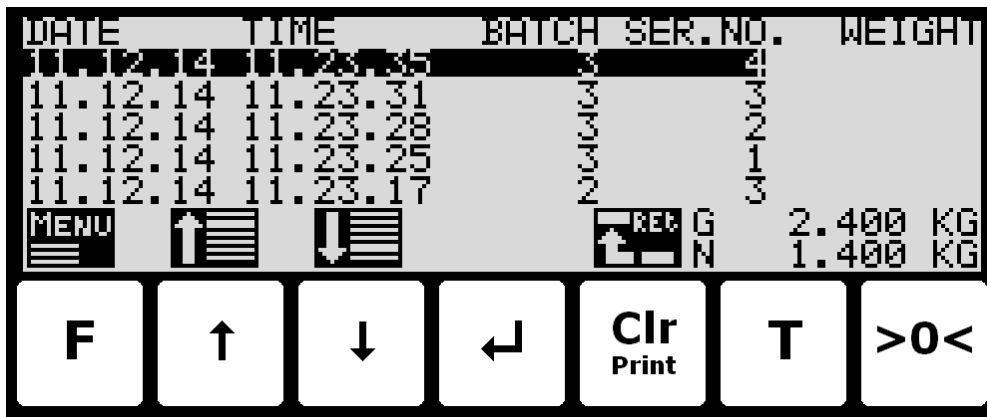

3.3 Registrations

Below the **REGISTRATIONS** screen is shown along with the keys that are enabled.



In this screen a list of performed registrations is shown in reversed order.

The keys are used as follows:

F	Selects the REGISTRATION MENU .
	Moves cursor (inverted text) up in the list of registrations.
	Moves cursor (inverted text) down in the list of registrations.
	Not used.
Clr	Return to the NORMAL screen.
T <input type="text"/>	Not used.
>0< <input type="text"/>	Not used.

3.3.1 Registration menu

When the **REGISTRATION MENU** is invoked the screen will look like this:

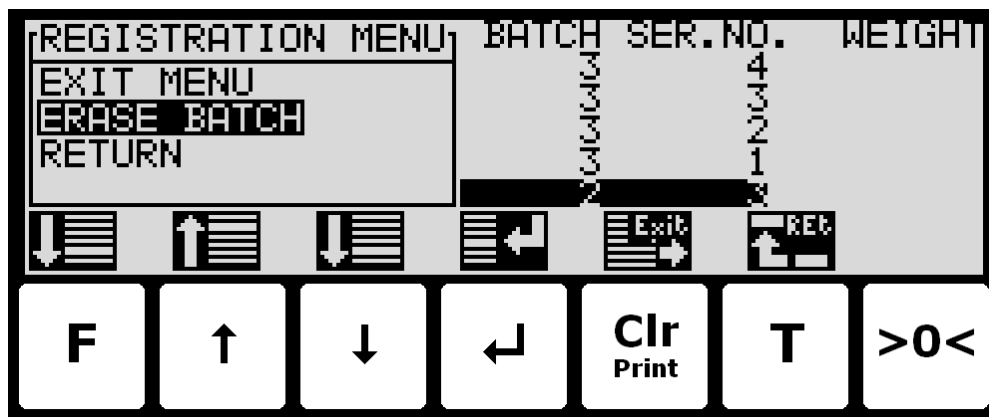



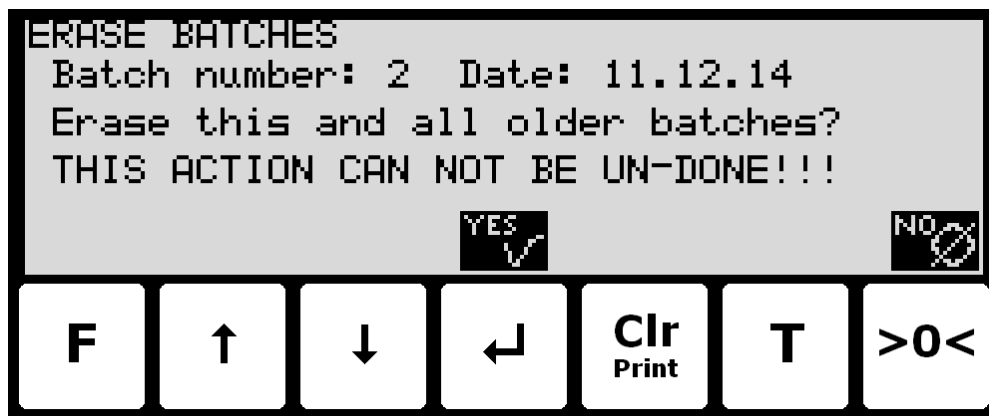

To erase the currently selected batch and all older batches select the “**ERASE BATCH**” menu item and press  this will invoke the **DELETE BATCH** confirmation screen.

3.3.2 Delete batch

When the **DELETE BATCH** confirmation screen is selected it will look like:



The keys are used as follows:

F	Not used.
	Not used.
	Not used.
	Deletes the indicated batch and all older batches. This action can not be undone and can be very time consuming (minutes)
Clr	Not used.
T 	Not used.
	Returns to the REGISTRATION screen without deleting batches.



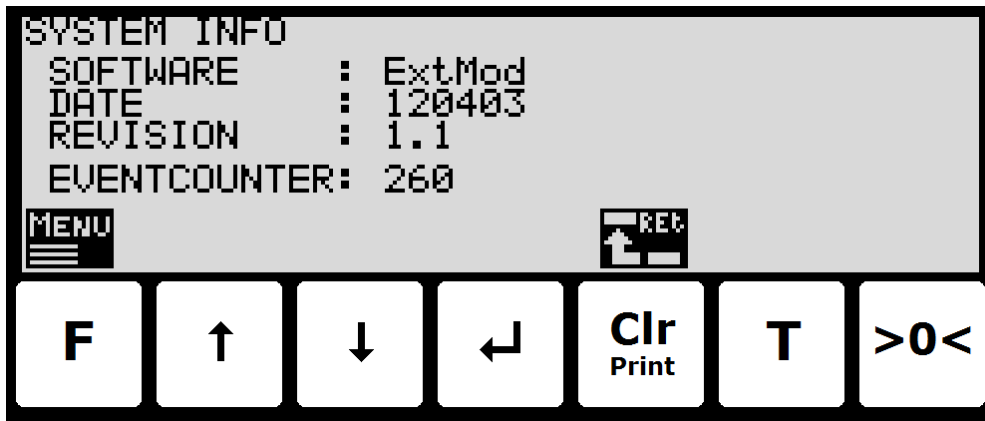

3.4 System Information

Below the **SYSTEM INFO** screen is shown along with the keys that are enabled.



In this screen program identification (consisting of software name, date and revision) and the event counter is shown.

The keys are used as follows:

F	Selects the INFO menu.
	Not used.
	Not used.
	Not used.
Clr	Return to the NORMAL screen.
T 	Not used.
	Not used.

3.5 System settings

Below the **SYSTEM SETTINGS** screen is shown along with the keys that are enabled.

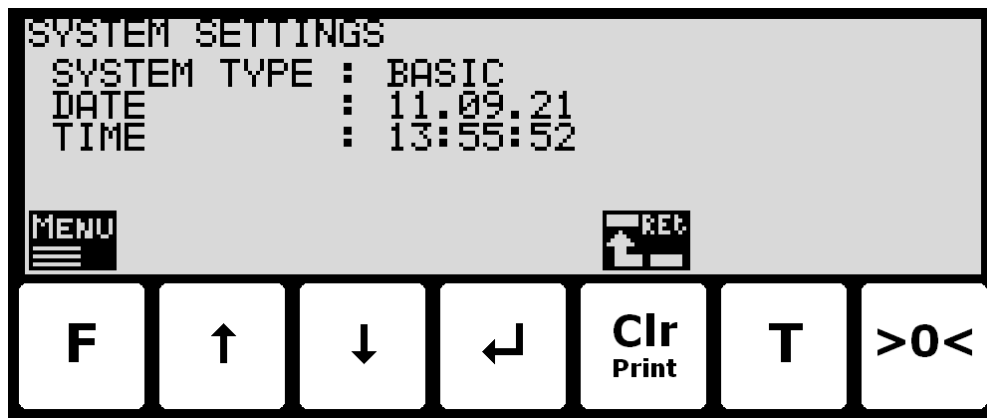

In this screen the system type is shown along with the current date and time.

The keys are used as follows:

↑	Not used.
↓	Not used.
↶	Not used.
Clr	Return to the NORMAL screen.
T	Not used.
>0<	Not used.



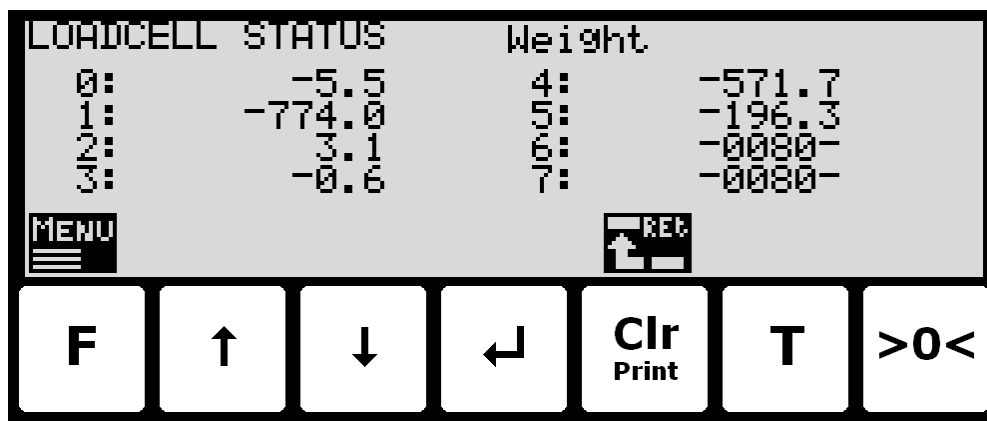

3.6 Loadcell status

Below the **LOADCELL STATUS** screen is shown along with the keys that are enabled.



In this screen the actual reading from each loadcell is shown.

The keys are used as follows:

F	Selects the LOADCELL STATUS menu.
	Not used.
	Not used.
	Not used.
Clr	Return to the SYSTEM INFO screen.
T 	Not used.
	Not used.

Three different readings can be selected with the menu:

- DIRECT:** The internal loadcell output value is displayed as it is received. This number is in SI units, but the resolution is loadcell dependent and may be an unusual value like 100mg, 10 gr. etc. Furthermore no zeroing is used and the loadcell value will NOT be 0 when the loadcell is empty, so this value is not the absolute load on this loadcell
- WEIGHT:** The loadcell output value in the resolution etc, selected for the display. No zeroing is used and the loadcell value will NOT be 0 when the loadcell is empty, so this value is not the absolute load on this loadcell.
- ZEROED:** The loadcell output value in the resolution etc, selected for the display. The value is zeroed along with the normal display reading. So this value is the change since the last zeroing.



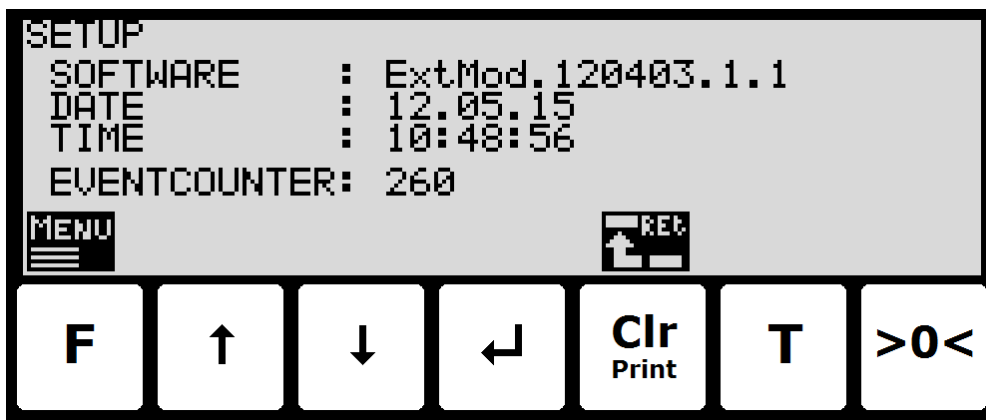

3.7 Service mode

Below the **SETUP** screen is shown along with the keys that are enabled.





In this screen the software version, actual date, actual time and event counter is shown.

The keys are used as follows:

F	Selects the SETUP menu.
	Not used.
	Not used.
	Not used.
Clr	Return to the NORMAL screen.
T 	Not used.
	Not used.

3.7.1 Setting date and time

It is possible to set the date and/or time of the internal clock by use of the **SETUP** menu. To set date and/or time from the **SETUP** screen perform the following:

F	Press once to select the SETUP menu.
	Press several times to select the "SET DATE" or "SET TIME" entry from the SET-UP menu.
	Press once to start entry of the selected parameter (date or time).





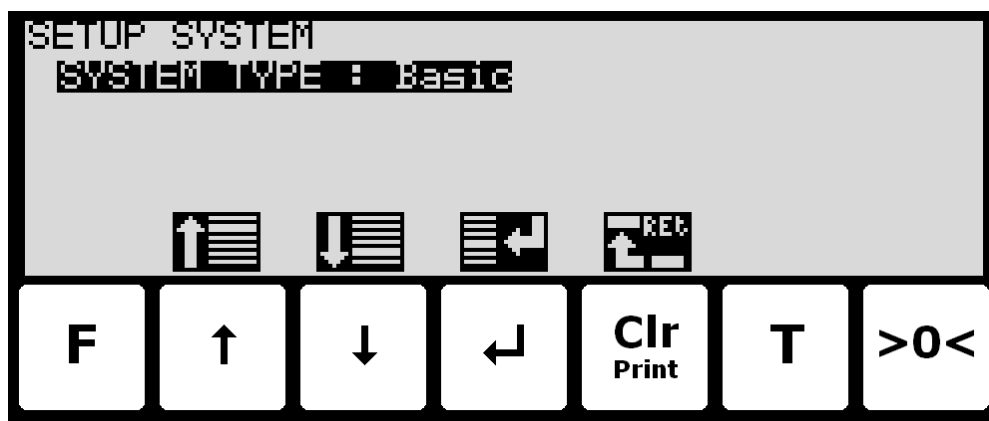

3.8 System

Below the **SETUP SYSTEM** screen is shown along with the keys that are enabled.



In this screen the system parameters are shown and can be changed. A cursor (inverted text) indicates the currently selected parameter.

The keys are used as follows:

F	Not used.
	Moves the cursor up between the different parameters on the screen.
	Moves the cursor down between the different parameters on the screen.
	Selects change/entry of the parameter marked/selected by the cursor.
Clr	Return to the SETUP screen.
T 	Not used.
	Not used.
	



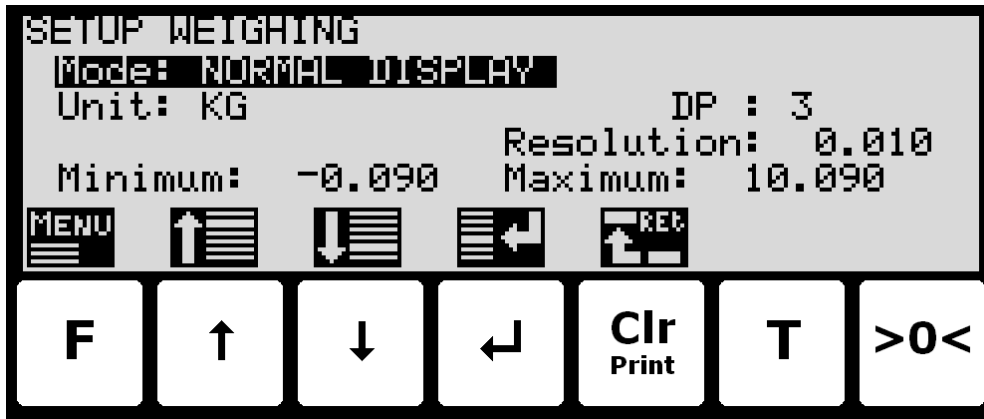

3.9 Weighing

Below the **SETUP WEIGHING** screen is shown along with the keys that are enabled.



In this screen weighing parameters are shown and can be changed. A cursor (inverted text) indicates the currently selected parameter.

The keys are used as follows:

F	Selects the WEIGHING menu.
	Moves the cursor up between the different parameters on the screen.
	Moves the cursor down between the different parameters on the screen.
	Selects change/entry of the parameter marked/selected by the cursor.
Clr	Return to the SETUP screen.
T 	Not used.
	Not used.

3.9.1 Weighing range modes

The weighing terminal is equipped with three different weighing range modes that specify the weighing range used for:

NORMAL:	weight readings during normal display reading.
CALIBRATION:	weight readings during calibration.
PROTOCOL:	weight readings transferred using serial communication.

The weighing range mode can be selected from the **SETUP WEIGHING** screen. The weighing range mode is changed by using \uparrow and \downarrow to select the "Mode" parameter with the cursor, and then pressing \leftarrow to request change of the "Mode" parameter using a selection list as described earlier.

When configuring weighing ranges as described below, values shown as well as changes made only apply to the currently selected weighing range specified by the "Mode" parameter.

3.9.2 Configuring weighing ranges

An appropriate weighing range can be configured from the **SETUP WEIGHING** screen. A specific weighing range is changed by using \uparrow and \downarrow to select a weighing range parameter with the cursor, and then pressing \leftarrow to request change of the given parameter. The following weighing range parameters need to be configured individually for each of the three specific weighing range modes (NORMAL, CALIBRATION and PROTOCOL):

- 1) "Unit" entered using a selection list as described earlier.
- 2) "DP" entered using a selection list as described earlier.
- 3) "Resolution" entered using a selection list as described earlier.
- 4) "Minimum weight" entered using data entry screen as described earlier.
- 5) "Maximum weight" entered using data entry screen as described earlier.



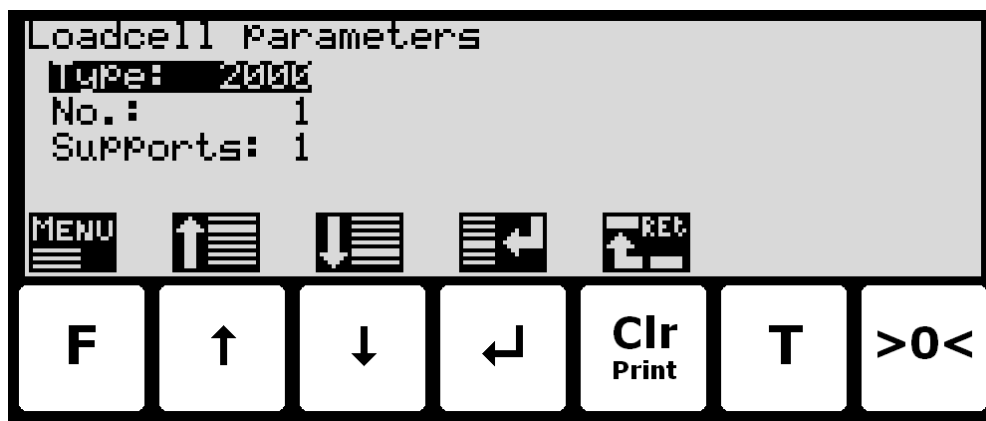

3.10 Loadcell parameters

Below the **LOADCELL PARAMETERS** screen is shown along with the keys that are enabled.



In this screen loadcell parameters are shown and can be changed. A cursor (inverted text) indicates the currently selected parameter.



The keys are used as follows:

F	Selects the WEIGHING menu.
	Moves the cursor up between the different parameters on the screen.
	Moves the cursor down between the different parameters on the screen.
	Selects change/entry of the parameter marked/selected by the cursor.
Clr	Return to the SETUP WEIGHING screen.
T <input type="text"/>	Not used.
	Not used.



3.10.1 Loadcell type

The weighing terminal can be connected to and communicate with different kinds of loadcells from Alfa Laval Kolding A/S. The weighing terminal can communicate with the following loadcells:



- Alfa Laval Electric loadcell type 2000
- Alfa Laval Electric loadcell type 4000

The type of loadcell connected to the weighing terminal must be specified in the **LOADCELL PARAMETERS** screen. The loadcell type indication is changed by using  and  to select the "Type" parameter with the cursor, and then pressing  to request change of the loadcell "Type" parameter using a selection list as described earlier.

3.10.2 Number of loadcells

The weighing terminal can be connected to a maximum of 16 loadcells. The actual number of loadcells connected to the weighing terminal must be specified in the **LOADCELL PARAMETERS** screen. The number of loadcells indication is changed by using  and  to select the "No." parameter with the cursor, and then pressing  to request change of the "No." of loadcells parameter.

3.10.3 Number of supports

The actual number of supporting points (1-8) in the weighing system must be specified in the **LOADCELL PARAMETERS** screen. The number of supporting points indication is changed by using  and  to select the "Supports" parameter with the cursor, and then pressing  to request change of the number of "Supports" parameter.

Note that it is the total number of supporting points including corners supported by loadcells. As an example, the "Supports" parameter should be 3 in a system consisting of a three legged tank.

3.11 Coarsetare

Below the **COARSETARE** screen is shown along with the keys that are enabled.

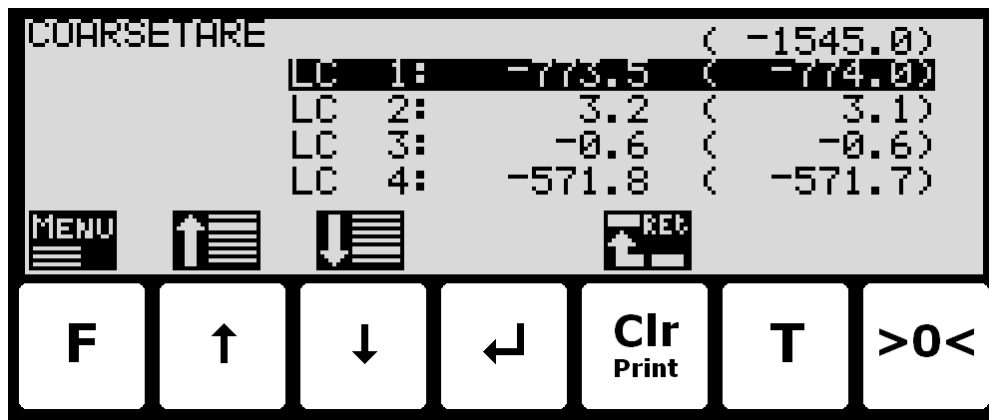

In this screen the coarsetare values and actual signals for each loadcell is shown.

The keys are used as follows:

F	Selects the COARSETARE menu.
	Selects the next coarsetare value
	Selects the previous coarsetare value
	Not used.
Clr	Return to the WEIGHING screen.
T	Not used.
>0<	Not used.

3.11.1 Performing coarsetare

It is possible to coarsetare the system by use of the **COARSETARE** menu. To perform a coarsetare from the **COARSETARE** screen perform the following:

F	Press once to select the COARSETARE menu.
	Press once to select the "PERFORM COARSETARE" entry from the COARSETARE menu.
	Press once to perform the coarsetare.

3.12 Zeroing

Below the **ZEROING** screen is shown along with the keys that are enabled.

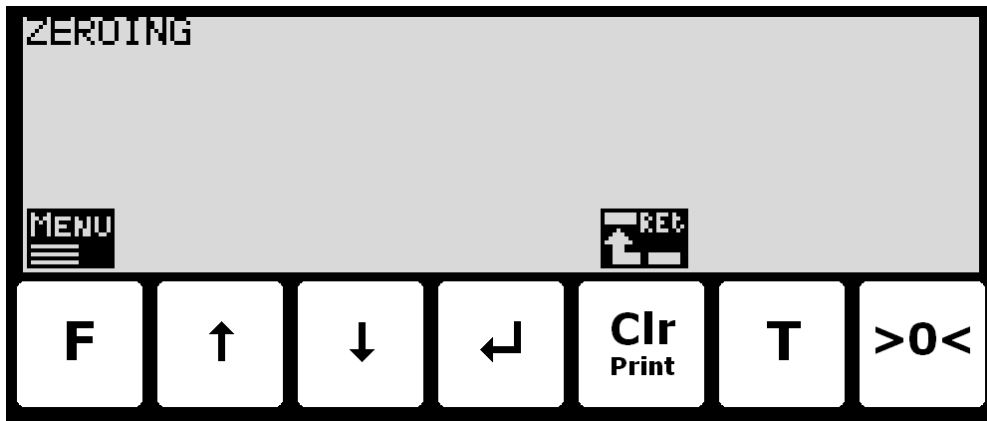

This screen is reserved for future use regarding zero. No features are implemented yet. The keys are used as follows:

F	Selects the ZEROING menu.
	Not used.
	Not used.
	Not used.
Clr	Return to the WEIGHING screen.
T	Not used.
	Not used.



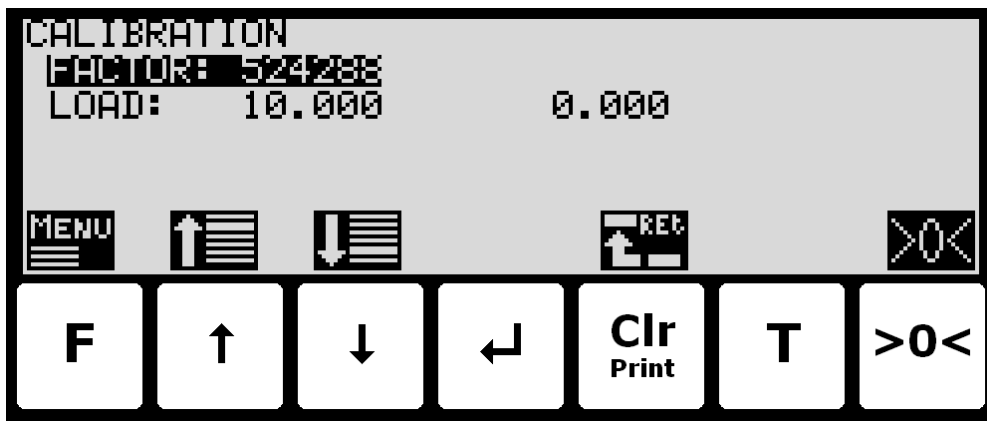

3.13 Calibration

Below the **CALIBRATION** screen is shown along with the keys that are enabled.





In this screen calibration parameters such as calibration factor, calibration load (to the left) and actual gross weight (to the right) are shown and can be changed. This makes it possible to calibrate the system. A cursor (inverted text) indicates the currently selected parameter.

The keys are used as follows:



F	Selects the CALIBRATE menu.
	Moves the cursor up between the different parameters on the screen.
	Moves the cursor down between the different parameters on the screen.
	Selects change/entry of the parameter marked/selected by the cursor.
Clr	Return to the SETUP WEIGHING screen.
T <input type="text"/>	Not used.
	Zeroes the gross reading shown to the right in the "Load" line.

3.13.1 Calibration factor

The actual system calibration factor can be changed/specified in the **CALIBRATION** screen by performing a calibration of the system as described below or by manually entering a new factor.



The calibration factor indication can be manually changed by using  and  to select the "FACTOR" parameter with the cursor, and then pressing  to request change of the calibration "FACTOR" parameter. This is useful when a previous calibration must be re-established. Note that this is only possible, if the calibration factor for this previous calibration is known. The standard calibration factor is 524288. If this value is changed 1% (up or down), the gross weight indication will also change 1% (up or down).

3.13.2 Calibration load

The actual mass of the load used for calibration must be specified in the **CALIBRATION** screen before calibration is performed. The calibration load indication is changed by using  and  to select the "LOAD" parameter with the cursor, and then pressing  to request change of the calibration "LOAD" parameter.

3.13.3 Perform calibration

It is possible to calibrate the system by performing the following calibration procedure (assuming the system has previously been coarsetared):

	Ensure the weighing scale is empty and clean.
	Press once to zero the gross reading of the empty weighing scale.
 <input type="text"/>	Press repeatedly until "LOAD" parameter is selected with the cursor.
	Press once to start entry of the actual calibration load if necessary. Please notice that the accuracy of the calibration is deeply dependant on the accuracy and size of the calibration load. Please select a load with a mass not less than the maximum weight normally applied to the system.

Place the load on the weighing arrangement. The gross weight of the load displayed to the far right in the "LOAD" line will now be inside +/- 10% of the correct reading. If this isn't the case the mechanical and electrical installation must be checked. Furthermore all weighing range parameters must be checked again.



Press once to select the **CALIBRATE** menu.



Press once to select the "PERFORM CALIBRATION" entry from the **CALIBRATE** menu.

Press once to perform the calibration.

The gross weight shown in the display will now match the used calibration load and the calibration factor will have been updated correspondingly.

3.14 Weight display

Below the **WEIGHT DISPLAY** screen is shown along with the keys that are enabled.

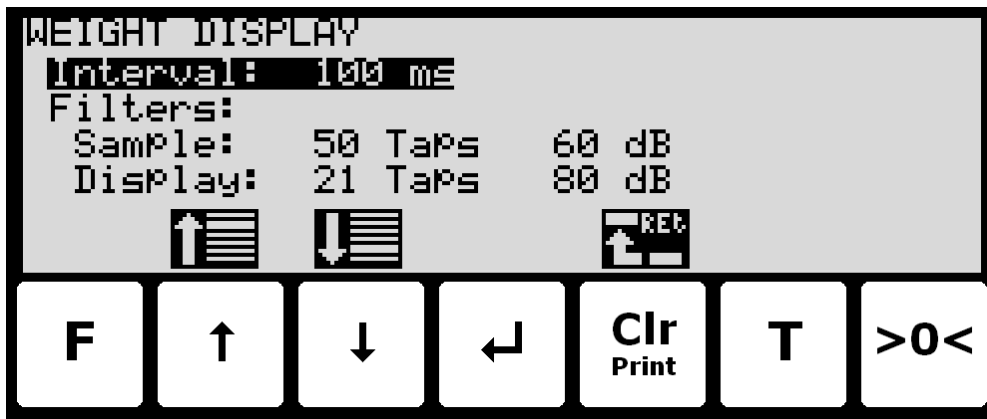

In this screen weight display parameters are shown and can be changed. A cursor (inverted text) indicates the currently selected parameter.

The keys are used as follows:



Not used.



Moves the cursor up between the different parameters on the screen.



Moves the cursor down between the different parameters on the screen.



Selects change/entry of the parameter marked/selected by the cursor.



Return to the **SETUP WEIGHING** screen.



Not used.



Not used.

3.14.1 Interval

The interval between each update of the weight indication must be specified in the **WEIGHT DISPLAY** screen. The interval indication is changed by using \uparrow and \downarrow to select the "Interval" parameter with the cursor, and then pressing \leftarrow to request change of the display "Interval" parameter.

The interval (measuring time) is entered in milliseconds (ms). A small value results in fast update of the display reading, while a larger value results in a more steady display reading. A good starting/default value is 400 ms.

3.14.2 Filters

Two types of filters can be applied: A filter on each sampling from the loadcell and/or a filter on each display weight reading update. The sampling frequency depends on the types and number of loadcells and the weight display reading update rate, as described below (Section 7.1 Appendix A: Filters). The weight display reading update rate is selected in the **WEIGHT DISPLAY** screen as described above. The filter selections are changed by using \uparrow and \downarrow to select the "Filters - Sample" and "Filters - Display" parameter with the cursor, and then pressing \leftarrow to invoke a filter selection list. The filter selections list will indicate the possible filter taps and damping; the filter frequency depends on the sampling/update rate.

Please see below (Section 7.1 Appendix A: Filters) for details on filter specifications.



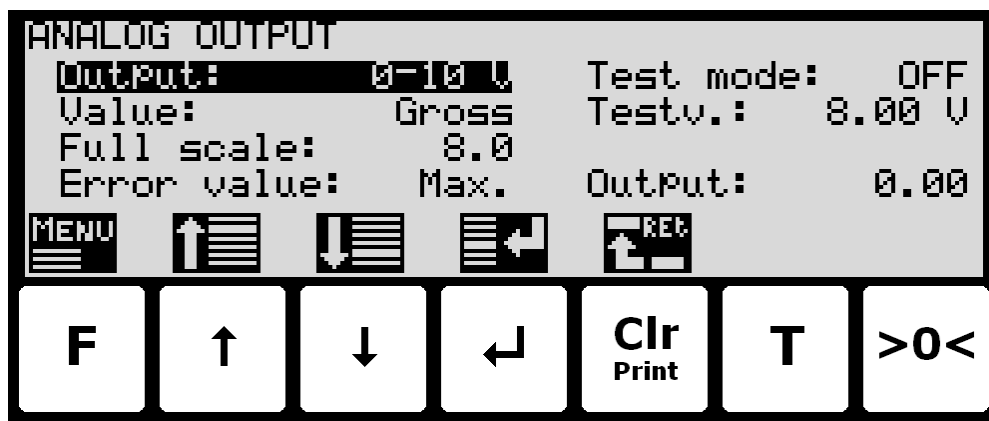

3.15 Analog output

Below the **ANALOG OUTPUT** screen is shown along with the keys that are enabled.



In this screen analog output parameters are shown and can be changed. A cursor (inverted text) indicates the currently selected parameter.

The keys are used as follows:

F	Selects the ANALOG OUTPUT menu.
	Moves the cursor up between the different parameters on the screen.
	Moves the cursor down between the different parameters on the screen.
	Selects change/entry of the parameter marked/selected by the cursor.
Clr	Return to the SETUP WEIGHING screen.
T <input type="text"/>	Not used.
	Not used.

3.15.1 Output type

The analog output type can be as current: 4-20mA or voltage: 0-10V. Please notice that voltage and current outputs are assigned to two different pins. The pin for the type not used will take a random voltage value from -15V to +15V. The maximum load resistor for current output is 500 ohm.

3.15.2 Output value

The value used to generate the analog output can be either the current gross weight or the current net weight.

3.15.3 Full-scale value

When the selected weight the analog output is at its minimum value (4mA or 0V). The maximum output value (20mA or 10V) is reached when the weight is at the entered full-scale value.

3.15.4 Error output value

When the selected weight cannot be calculated e.g. due to loadcell not connected or loadcell error the analog output can be selected to be at the minimum value (4mA or 0V) or the maximum output value (20mA or 10V).

3.15.5 Test output

When the Test Mode is set to *ON* the analog is not controlled by the current weight but by the test value entered.

3.16 Ethernet

The **SETUP ETHERNET** screen is described separately in the "ETHERNET COMMUNICATION" chapter.

3.17 External module

An external module can be connected to the RS485 channel. This external module can be used for Profibus or DeviceNet connectivity.

The **EXTERNAL MODULE** and **EXTERNAL MODULE DATA** screens are described separately in the "EXTERNAL MODULES" chapter.

4) Ethernet communication

4.1 Ethernet specification

Protocol:	TCP/IP to PC. Weight terminal is TCP server
Communication settings	10MB/s, Half duplex
IP-Address:	Fixed (default: 192.168.1.199)
TCP Port:	Selectable
Ethernet connection:	RJ45/Cat5

4.1.1 Registration

Whenever a registration is made. The result is transmitted as an ASCII string on the TCP connection. This is only done if a client is connected to the weight terminal TCP server. Only 1 TCP connection can be opened. The transmission format is

```
NNN . NNN , GGG . GGG <CR> <LF>
```

NNN . NNN	Net weight with decimal point position and resolution as in display reading.
GGG . GGG	Gross weight with decimal point position and resolution as in display reading.
<CR> <LF>	Carriage return and linefeed characters.

4.1.2 PC Test software

The Ethernet communication can be tested with the EEOnline software. Just copy the .EXE and .INI file to a suitable location and run EEOnline.exe. Enter the IP address and the port. When then PC and the 5024 is on the same network segment a connection can be established by clicking "Connect".

4.2 Ethernet

Below the **SETUP ETHERNET** screen is shown along with the keys that are enabled.

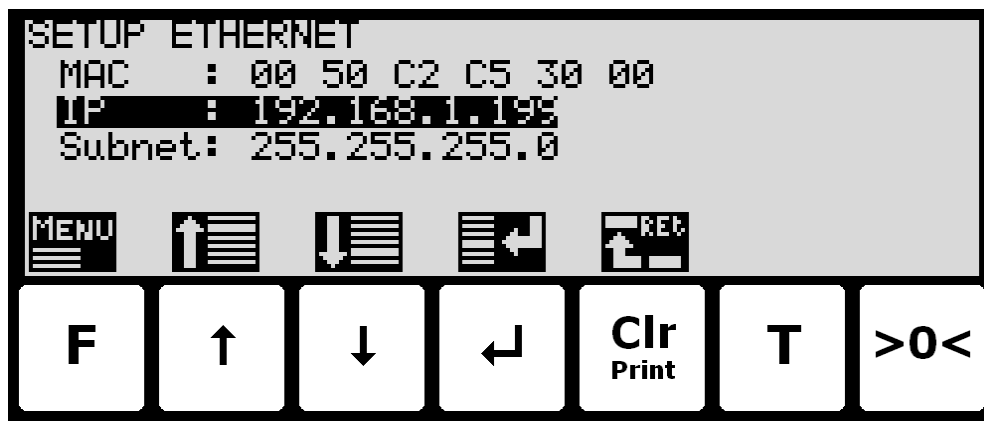



In this screen the different Ethernet parameters are shown and can be changed. A cursor (inverted text) indicates the currently selected parameter.

The keys are used as follows:

F	Selects the ETHERNET menu.
↑	Moves the cursor up between the different parameters on the screen.
↓	Moves the cursor down between the different parameters on the screen.
←	Selects change/entry of the parameter marked/selected by the cursor.
Clr	Return to the SETUP screen.
T	Not used.
>0<	Not used.

4.2.1 Ethernet settings

Appropriate Ethernet settings can be selected from the **SETUP ETHERNET** screen. Ethernet settings are changed by using  and  to select an Ethernet parameter with the cursor, and then pressing  " to request change of the given parameter. The following Ethernet parameters can be configured:

- 1) "IP" address entered using a data entry screen as described earlier.
- 2) "Subnet" mask entered using a data entry screen as described earlier.



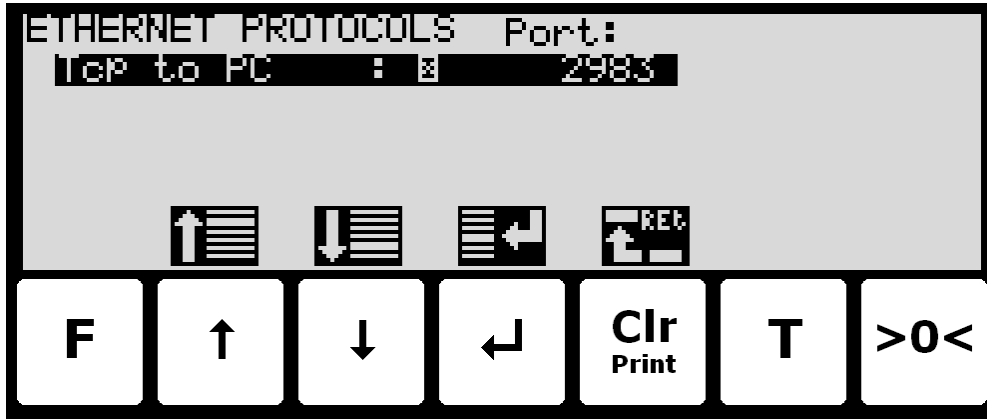

4.3 Ethernet Protocols

Below the **ETHERNET PROTOCOLS** screen is shown along with the keys that are enabled.



In this screen the different Ethernet protocols are shown and can be changed. A cursor (inverted text) indicates the currently selected protocol.

The keys are used as follows:

F	Not used.
	Moves the cursor up between the different parameters on the screen.
	Moves the cursor down between the different parameters on the screen.
	Selects change of the protocol settings for the protocol selected.
Clr	Return to the ETHERNET screen.
	Not used.
	Not used.

4.3.1 Ethernet protocol settings

Each Ethernet protocol can be enabled or disabled. When the protocol is enabled the port-number can be entered.

5) External modules

5.1 Introduction

The 5024G can be connected to one external module. This module can be either a Profibus, DeviceNet or EtherNetIP module. The EtherNetIP module is only used for testing as the 5024 comes with built in Ethernet connectivity.

With the software versions stated below installed in the external module the external communication module can function as a slave on the AUX-bus (RS485), where it transfers 14 input bytes from the RS485 master (5024G) to the Profibus/DeviceNet master and 14 output bytes from the Profibus/DeviceNet master to the RS485 master (5024G).

Exchange of data between master and slave is made according to the profile/protocol described below.

5.2 External module

Below the **EXTERNAL MODULE** screen is shown along with the keys that are enabled.

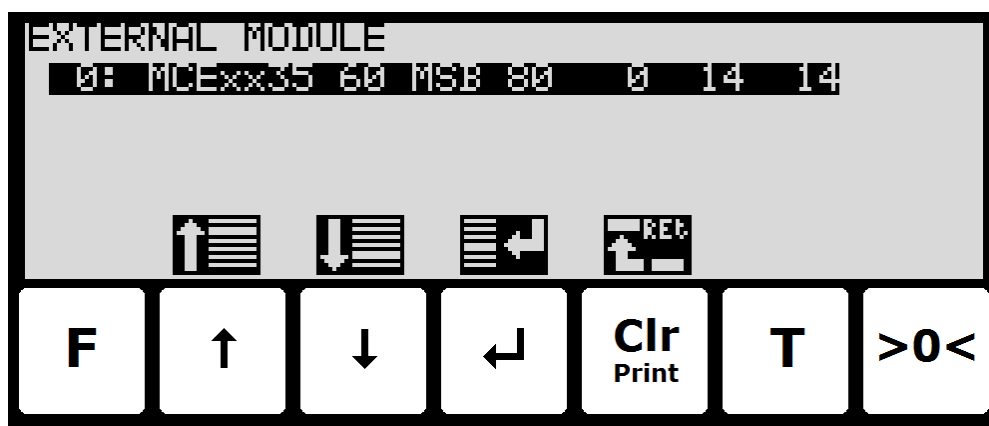





In this screen the external module is shown and can be changed. A cursor (inverted text) indicates the currently selected module. With this version of the software only one module can be installed.

The line with module data shows the following information:

Device Index:	Always 0 with this software version.
Device Type:	----- if no external module is connected. <i>MCExx35</i> if a Profibus module is connected. <i>MCE9637</i> if MCE9637 DeviceNet module is connected. <i>2X50</i> if a 2X50 EtherNetIP module is connected for test purposes.
Device Address:	The address is the entered address plus the base address for the module type selected
Endian:	Endian of the individual data values transferred: <i>MSB</i> most significant byte first: Big endian. <i>LSB</i> least significant byte first: Little endian. <i>MSB</i> is normally used with Profibus while <i>LSB</i> is normally used with all other types of modules
Status:	<i>00</i> : Communication up and running. <i>80</i> : No connection to the module.
Error Counter:	Number of errors in communication
Bytes Out:	Number of bytes to be sent from the 5024G to the external module and from there to the Profibus/DeviceNet master. This is the number of input bytes in the Profibus/DeviceNet master.
Bytes In:	Number of bytes to be received in the 5024G from the external module and in the external module from the Profibus/DeviceNet master. This is the number of output bytes in the Profibus/DeviceNet master.

The keys are used as follows:

- F Not used.
-  Moves the cursor up between the different modules on the screen.
-  Moves the cursor down between the different modules on the screen.
-  Selects change of the settings for the selected module.
- Clr Return to the **SETUP** screen.
- T Not used.
-  Not used.

The following parameters can be changed for the external module:

- Device Type:** The following types can be selected. *None* if no external module is connected. *MCExx35* if a Profibus module is connected. *MCE9637* if MCE9637 DeviceNet module is connected. *2X50* if a 2X50 EtherNetIP module is connected for test purposes.
- Device Address:** The address is automatically added to the base address for the module type selected. Enter a number in the interval 0-15. With this software version where only one external module can be connected 0 is the normal address value.
- Endian:** Endian of the individual data values transferred: *MSB* most significant byte first: Big endian. *LSB* least significant byte first: Little endian. MSB is normally used with Profibus while LSB is normally used with all other types of modules.
- Bytes Out:** Number of bytes to be sent from the 5024G to the external module and from there to the Profibus/DeviceNet master. This is the number of input bytes in the Profibus/DeviceNet master. The values must be the same as the value in the external module. Normally 14.
- Bytes In:** Number of bytes to be received in the 5024G from the external module and in the external module from the Profibus/DeviceNet master. This is the number of output bytes in the Profibus/DeviceNet master. The values must be the same as the value in the external module. Normally 14.





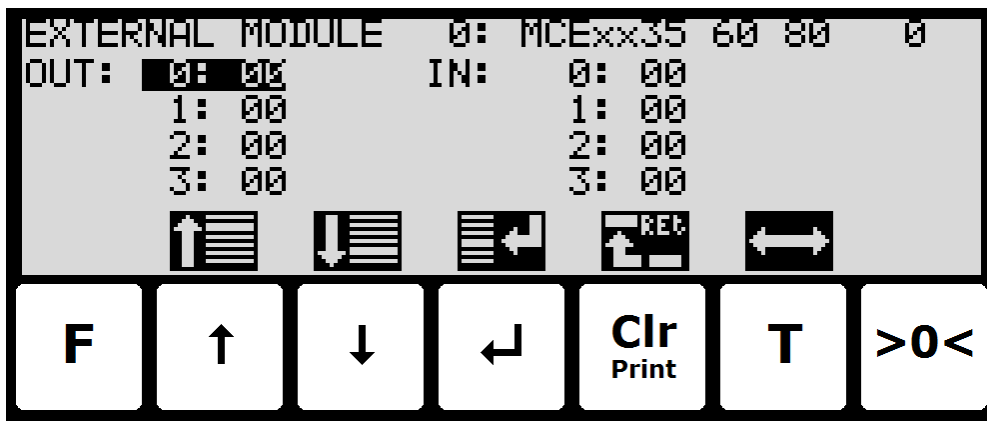

5.3 External module data

Below the **EXTERNAL MODULE DATA** screen is shown along with the keys that are enabled.



This screen will show the data sent to the external module (*OUT*) and the data received from the external module (*IN*).

The keys are used as follows:

F	Not used.
	Moves the cursor up between the data bytes.
	Moves the cursor down between the data bytes.
	Selects entry of the selected input data byte for test purposes. If an external module is communication the value will immediately be overwritten by the value receive form the external module..
Clr	Return to the EXTERNAL MODULE screen.
T 	Toggles the cursor between the output and the input bytes.
	Not used.
	

5.4 External communication using PPO

The communication with the external module is made using a 'parameter-process data object' (PPO) consisting of 14 bytes data. This telegram (object) is used during both reception and transmission of data. The structure of this telegram is as follows:

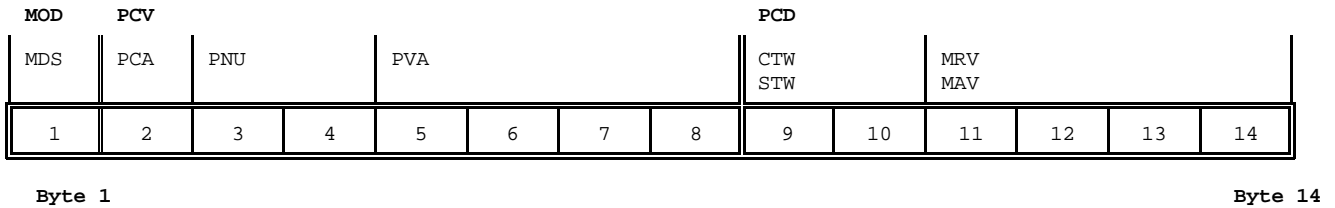

The telegram is made up of 3 blocks; a MOD part (1 byte), a PCV part (the next 7 bytes) and a PCD part (the last 6 bytes). The three blocks are as follows:

MOD (Mode)

MDS (Byte 1): Mode selector

PCV (Parameter-Characteristic-Value)

PCA (Byte 2): Parameter Characteristics
 PNU (Bytes 3-4): Parameter number
 PVA (Bytes 5-8): Parameter value

PCD (Process Data)

CTW (Bytes 9-10) (Master to Slave): Control Word
 STW (Bytes 9-10) (Slave to Master): Status Word
 MRV (Bytes 11-14) (Master to Slave): Main Reference Value
 MAV (Bytes 11-14) (Slave to Master): Main Actual Value

In the following the meaning of the individual blocks of the telegram is explained further.

IMPORTANT: During transfer/reception of data (i.e. the MAV) it is up to the master (the PLC) to ensure consistent data, when a parameter consisting of several bytes is read/updated and when AS/MAV or RS/MRV is read/set.

5.5 MOD

The MOD part of the telegram indicates which value is to be transferred as **Main Reference Value** (MRV) and as **Main Actual Value** (MAV). Please see below for further information.

5.5.1 MDS

MDS contains an RS part for selection of **Main Reference Value** (MRV) and an AS part for selection of **Main Actual Value** (MAV), as shown in the figure below.

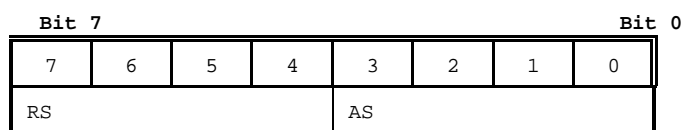

RS: Reference value selector (Values: 0..15)
AS: Actual value selector (Values: 0..15)

5.6 PCV Description

The PCV part of the telegram is made up of a PCA part, a PNU part and a PVA part. The function of these different parts of the PCV part is described here.

5.6.1 PCA

The PCA part contains an RC part for 'request' and 'response' indication.

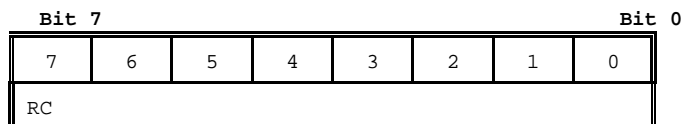

RC: Request/Response Characteristics (Values: 0..255)

RC is used by the master to tell the slave which 'request' is desired. Similarly the slave uses RC to inform the master the status of the received 'request' ('response'). The contents of RC has the following function during 'request':

REQUEST	FUNCTION
0	No request
1	Request parameter value
2	Change parameter value (2 bytes)
3	Change parameter value (4 bytes)
<i>Others</i>	<i>Reserved for future use</i>

The contents of RC has the following function during response:

RESPONSE	FUNCTION
0	No response
1	Transfer parameter value (2 bytes)
2	Transfer parameter value (4 bytes)
3	Request rejected (incl. Error#, see later)
4	Cannot be serviced by PCV interface
<i>Others</i>	<i>Reserved for future use</i>

5.6.2 PNU

The PNU part indicates the parameter number of the parameter to be read/changed. The parameters and their function is described below.

5.6.3 PVA

The PVA part contains 4 bytes for reception and transmission of parameter values. The PVA part transfers '2 byte' parameters in bytes 5 and 6, while '4 byte' parameters are transferred in bytes 5 and 8.

If the slave rejects a request from the master the RC part assumes the value 3 (see above) and the error number itself is transferred in the PVA part (bytes 5 and 6). The following error indications are possible:

ERROR #	CAUSE
0	Illegal command for this PNU or PNU not used.
1	<i>Reserved for future use</i>
2	Upper or lower limit exceeded

5.7 PCD Description

The PCD part of the telegram is made up of a CTW/STW part and a MRV/MAV part. The function of these two parts of the PCD part is described here. Note that the PCD part (the last 6 bytes) always transfers these data disregarding the contents of the PCV part.

5.7.1 CTW/STW

During communication from the master to the slave, the first two bytes of the PCD part are used as a Control Word (CTW). Using the Control Word (CTW) it is possible to tell the slave how to react as different commands can be transferred to the slave.

During communication from the slave to the master, the first two bytes of the PCD part are used as a Status Word (STW). Using the Status Word (STW) it is possible for the master to gain information on the status of the slave.

5.7.2 MRV/MAV

During communication from the master to the slave the last four bytes of the PCD part are used as a **Main Reference Value** (MRV); a setpoint. Using the RS defines exactly which value is transferred as MRV.

During communication from the slave to the master the last four bytes of the PCD part are used as a **Main Actual Value** (MAV); the actual value. Using the AS defines exactly which value is transferred as MAV.

5.8 Communication overview

Please note the following:

1. All weights are transferred as shown in the display without a decimal point (i.e. 300.0 kg is transferred as 3000 and 67.2 kg is transferred as 672).
2. All negative numbers are transferred as 2-complement numbers.

5.9 RS –Reference Value Selector, MRV – Main Reference value

RS Reference value selector	MRV Main Reference value
0	<i>Not used</i>
<i>Others</i>	<i>Not used</i>

5.10 AS –Actual Value Selector, MAV – Main Actual value

AS Actual value selector	MAV Main Actual value
0	<i>Not used</i>
1	Actual gross weight
2	Actual net weight
<i>Others</i>	<i>Not used</i>

5.11 CTW –Control Word

Bit	Function
0	Zero
1	Autotare (zero of net weight)
<i>Others</i>	<i>Not used</i>

Zero must be activated if a zero of the gross weight is desired.

Autotare must be activated if a zero of the net weight is desired.

5.12 STW –Status Word

Bit	Function
0	Weight reading not possible
1	Zero OK
2	Zero not possible
3	Autotare OK
4	Autotare not possible
<i>Others</i>	<i>Not used</i>
15	OK – always ON

Weight reading not possible is active when the 5024G terminal is unable to determine the weight.

Zero OK is active when zero was possible.*)

Zero not possible is active when zero was NOT possible.*)

Autotare OK is active when autotare was possible.*)

Autotare not possible is active when autotare was NOT possible.*)

Bits marked with *) are cleared again when the corresponding request bit is cleared.

5.13 Parameters

NO	TYPE	PARAMETER
1	4, R	Actual gross weight
2	4, R	Actual net weight
10	2, R	Unit 1: gram 2: kg 3: ton
11	2, R	Decimal point position
20 - 27	2, R	Loadcell-Status[x]
40 - 47	4, R	Loadcell-Gross[x]
<i>Others</i>		<i>Not used</i>

Unit indicates the unit used in the display reading. It should be used to scale weight indications received/transmitted using the DeviceNet communication.

Decimal point position indicates the number of digits after the decimal point in the display reading. It should be used to scale weight indications received/transmitted using the DeviceNet communication.

Loadcell-Status[x] contains the actual status for loadcell x.

Loadcell-Gross[x] contains the actual gross weight on loadcell x.

6) Hardware description

The following describes the main hardware features such connection of power, connection of loadcells, various connectors and jumpers as well as internal indicators (LEDs).

6.1 Rear view

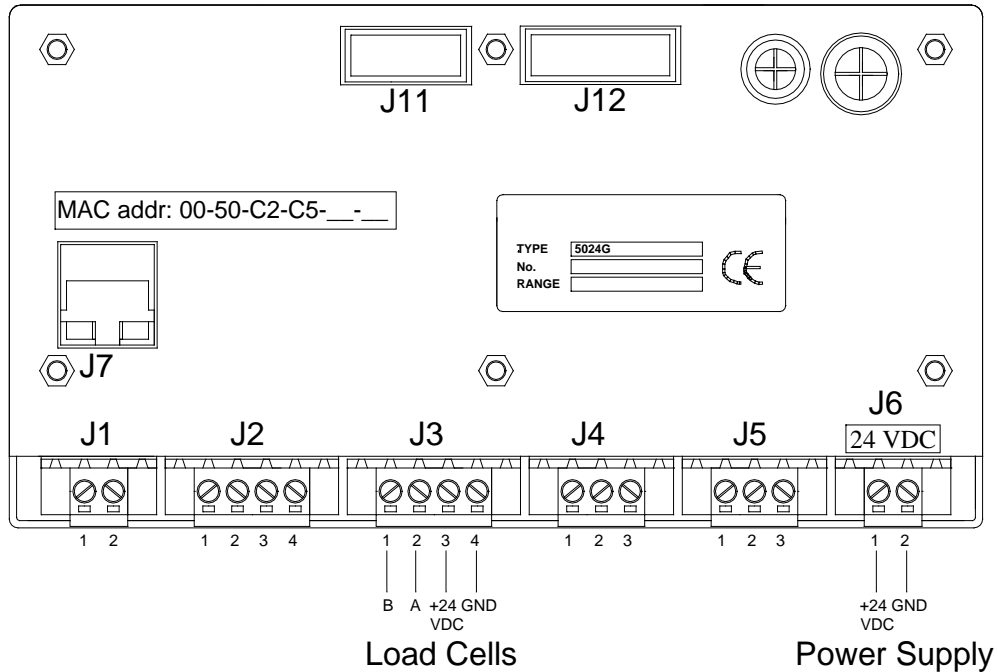

6.2 Connection of power

The 5024 system is powered by +24VDC which is connected to either J1 or J6. This powers the entire system including the connected loadcell.

<u>J1 pin</u>	<u>FUNCTION</u>
1	+24V
2	GND

<u>J6 pin</u>	<u>FUNCTION</u>
1	+24V
2	GND

6.3 Loadcell connection

Loadcells can be connected to the system in one of the following three ways:

- J11 connector using a ribbon cable to System 2000 loadcell modules (without use of MCE9601).
- J3 connector using a shielded cable to System 2000 loadcell modules, by using a MCE9601 connector module

<u>J3 pin</u>	<u>FUNCTION</u>
1	RS485-B (negative line)
2	RS485-A (positive line)
3	+24V (output – may be used to supply the loadcells)
4	GND

- J12 connector using a ribbon cable to a 4015 loadcell connection module, for System 4000 loadcells.

6.4 Digital I/O connector

The 4 pin digital I/O connector (J2) can be used for connecting digital inputs and outputs to the 5024 system.

This connector has the following pin-out:

<u>J2 pin</u>	<u>FUNCTION</u>
1	IO_1 INPUT: Register weigh
2	IO_2 INPUT: Tare weight reading (zero net reading)
3	IO_3 OUTPUT: Scale ready: No errors
4	IO_4 OUTPUT: Registration done Mode. On as long as INPUT 1 is on.

6.5 RS485 communication connector (Profibus)

The 3 pin RS485 serial communication connector (J4) can be used for RS485 communication with externally connected equipment: 2035 Profibus module or . This connector has the following pin-out:

<u>J4 pin</u>	<u>FUNCTION</u>	<u>Connection</u>
1	RS485-B (negative line)	External module MCE9601: B
2	RS485-A (positive line)	External module MCE9601: A
3	RS485-GND	External module MCE9601: Gnd

6.6 Analog output connector

The 3 pin analog output connector (J5) can be used for output of analog control signals from the 5024 system. This connector has the following pin-out:

<u>J5 pin</u>	<u>FUNCTION</u>
1	Analog GND
2	Analog current output Maximum load resistor: 500 ohm
3	Analog voltage output

6.7 Ethernet connector

The RJ45/Cat5 Ethernet connector (J7) is a standard Ethernet connector that can be used to connect the 5024 system to Ethernet.

6.8 Jumper settings

The 5024 system is equipped with a number of jumpers. These jumpers have the following functionality:

JUMPER	FUNCTION
JP1	Reset The jumper allows reset of the on-board microcontroller. OFF: Normal operation (normal setting from factory) ON: Reset of the 5024 on-board microcontroller
JP2	BOOT Load The jumper is used when downloading new software to the 5024 system using the J8 serial connector. OFF: Normal power-up/operation (normal setting from factory) ON: Download operation possible (see download description)
JP3	Configuration jumper (Reserved for future use)

6.9 Light Emitting Diodes (LEDs)

The 5024 system is equipped with a number of internal lamps (light emitting diodes). These have the following functionality:

LED	FUNCTION
D7 (Green)	Loadcell Tx (RS485) Data is transmitted to the loadcell.
D8 (Red)	Loadcell Enable (RS485) Transmission to the loadcell is enabled.
D9 (Yellow)	Loadcell Rx (RS485) Data is received from the loadcell.
D16 (Yellow)	External Rx (RS485) Data is received from external equipment.
D17 (Red)	External Enable (RS485) Transmission to external equipment is enabled.
D18 (Green)	External Tx (RS485) Data is transmitted to external equipment.

6.10 MCE2035 Profibus module

If a 2035 Profibus module is connected it must have the following software version:

MCE2535.AUXSLAVE.050909.0 (O14_I14)

It is possible to connect the 2035 communication module on a PROFIBUS-DP network, where it will act as a slave. It will then be possible from the PROFIBUS-DP master to transfer data to/from the 5024G terminal (RS485 master).

6.10.1 Profibus DP specification

The 2035 communication module conforms to the following PROFIBUS specifications:

Protocol:	Profibus-DP
Communications form:	RS485
Module type:	Slave
Baud rates [kbit/sec]:	9.6, 19.2, 93.75, 187.5, 500, 1500, 3000, 6000, 12000
Profibus address:	0-127 (Sw2.2-Sw2.8)
Profibus connection:	9-pin sub-D (female) connector

6.10.2 Checklist during installation

During installation of the system the following should be checked/performed:

- 1) The Profibus-DP master is configured to communicate with the Profibus-DP module (2035) using the supplied GSD file.
- 2) The Profibus-DP module (2035) is connected to the Profibus-DP network, and a possible termination at the Profibus-DP slave is made.
- 3) The Profibus-DP module (2035) address is set using Sw2.1- Sw2.7. Power is applied and the Profibus-DP communication is started.
- 4) Check that yellow LEDs (DES and RTS) of the Profibus-DP module (2035) are lit/flashing, and that the green LED (D1) flashes. Check that the TXBB LED on the Profibus-DP module flashes and that the red LED (PBE) is not lit.

6.10.3 2035 Connection

The 10 pole connector (J2) on the 2035 module is connected to the 10 pole connector on the MCE9601 connection module using the supplied ribbon cable with mounted connectors. Through this bus cable connection of power supply is achieved and connection to the RS485 master.

The MCE9601 module has the following connections in the blue connector (J1):

MCE9601 CONNECTOR	CONNECTION
GND	-
B (DATA-)	5024G J4.1: RS485-B
A (DATA+)	5024G J4.2: RS485-A
GND	-
+24V	+24VDC (Vin)
GND	5024G J4.3: 0 VDC (GNDin)
I/O	-

The 10 pole connector (J2) on the 2035 Profibus-DP module has these connections:

2035 J2 CONNECTER	FUNCTION
J2.1 - J2.2	RS485-B (DATA-)
J2.3 - J2.4	RS485-A (DATA+)
J2.5 - J2.6	0 VDC (GNDin)
J2.7 - J2.8	+24VDC (Vin)
J2.9 - J2.10	I/O line

Please notice that the internal Jumper JU 1 must be ON (inserted).

6.10.4 DIP-switch settings

The 2035 PROFIBUS-DP module is equipped with DIP-switch blocks that have the following function:

SWITCH	FUNCTION
Sw1.1-Sw1.4	<p>Selection of AUX communication address</p> <p>The address is selected as the DIP-switches are binary coded, so that Sw1.1 is LSB and Sw1.4 is MSB. Note that these switches are only read during power on. The address should <u>not</u> be set so that the module has an address that matches another Profibus module on the same AUX bus. The modules should be numbered from 0 and upwards without skipping any numbers. If only one module of a given type is connected to the AUX bus all switches should be.</p>

SWITCH	FUNCTION
Sw2.1-Sw2.7	Selection of PROFIBUS-DP communication address The address is selected as the DIP-switches are binary coded, so that Sw2.1 is LSB and Sw2.7 is MSB. Note that these switches are only read during power on.
Sw2.8	<i>Reserved for future use</i>

6.10.5 Light Emitting Diodes

The 2035 PROFIBUS-DP module is equipped with 6 light emitting diodes (LED). These LED's have the following function:

LED	FUNCTION
TXBB (Green)	Communication with AUX-master 2035 is communicating with AUX-master.
D1 (Green)	Communication with AUX-master Toggles when the 2035 module receives a valid telegram on the AUX-bus.
D2 (Green)	<i>Reserved for future use</i>
PBE (Red)	Profibus Error (when initialising the SPC3) The SPC3 profibus controller was not initialised correctly.
DES (Yellow)	Data Exchange State Exchange of data between slave and master.
RTS (Yellow)	RtS signal (SPC3) The Profibus module sends to the master.

6.10.6 PROFIBUS-DP connector

The 2035 PROFIBUS-DP module is equipped with a nine pole female sub-D connector (J1) for connection to the PROFIBUS-DP network. The connector is a standard PROFIBUS-DP connector. Termination of the PROFIBUS should take place in the sub-D connector (male) of the cable. The specific terminals in the connector have the following function:

<u>J1 Terminals</u>	<u>Function</u>
J1.1	Not used
J1.2	Not used
J1.3	RS485-A (positive line) (Siemens designation: B line)
J1.4	Request to Send (RTS)
J1.5	0 VDC (Gnd)
J1.6	+5VDC (Vout)
J1.7	Not used
J1.8	RS485-B (negative line) (Siemens designation: A line)
J1.9	Not used

Note that some companies use different designations for the RS485-A and the RS485-B lines. Therefore the polarity of the lines has been listed.

6.10.7 Jumpers

The 2035 PROFIBUS-DP module is equipped with 4 jumpers. These jumpers have the following function:

JUMPER	FUNCTION
JU1	Baudrate on the AUX bus. OFF: Communication at 9600 bps. ON: Communication at 115200 bps. (MUST be in this position for communication with 5024G) (Normally the jumper will be mounted on delivery.)

JU2-JU4	Alternative termination of the Profibus. If R17, R21 and R22 are mounted these jumpers can be used to connect the termination resistors, so this is done directly on the module and not the normal way in the Profibus connectors
---------	---

6.10.8 2035 Hardware Selftest

During power-on the 2035 module will perform a hardware selftest. The test will cause the light emitting diodes D1, D2 and PBE to turn on and off shortly, one at a time.

6.11 MCE9637 Profibus module

If a MCE9637 DeviceNet module is connected it must have the following software version:

9637C_DN.AUXSLAVE.O14_I14.000529.1

It is possible to connect the MCE9637 communication module on a DeviceNet, where it will act as a slave. It will then be possible from the DeviceNet master to transfer data to/from the 5024G terminal (RS485 master).

6.11.1 DeviceNet specification

The following DeviceNet specifications apply to the MCE9637 communication module:

Protocol:	DeviceNet
Communication media:	CAN
Module type:	Group 2 slave (Polled I/O)
Baud rates [kbit/sec]:	125, 250, 500 (SW2.1-SW2.2)
DeviceNet MAC ID:	0-63 (SW2.3-SW2.8)
DeviceNet connection:	5-pin Open Connector (male)

6.11.2 Checklist during installation

During installation of the system the following should be checked/performed:

- 1) If necessary configure the DeviceNet master to communicate with the DeviceNet module (MCE9637) using the supplied EDS file.
- 2) The DeviceNet module (MCE9637) is connected to the DeviceNet, and a possible termination at the DeviceNet slave is made.
- 3) The DeviceNet module (MCE9637) baudrate is set using Sw2.1-Sw2.2 and its address is set using Sw2.3- Sw2.8. Power is applied and the DeviceNet communication is started.
- 4) Check that yellow LED (D1) of the DeviceNet module (MCE9637) is lit, and that the red LED (D2) flashes. Check that the TXBB LED on the DeviceNet module flashes. Check that both the MS and the NS LED on the DeviceNet module (MCE9637) end up being lit solid green.

6.11.3 DIP-switch settings

The MCE9637 module is equipped with two DIP-switch blocks. DIP-switch block 1 has the following function:

SWITCH	FUNCTION
Sw1.1-Sw1.4	<p>Selection of AUX communication address</p> <p>The address is selected as the DIP-switches are binary coded, so that Sw1.4 is LSB and Sw1.1 is MSB. Note that these switches are only read during power on. The address should <u>not</u> be set so that the module has an address that matches another DeviceNet module on the same AUX bus. The modules should be numbered from 0 and upwards without skipping any numbers. If only one module of a given type is connected to the AUX bus all switches should be.</p>

DIP-switch block 2 has the following function:

SWITCH	FUNCTION
Sw2.1-Sw2.2	<p>Setting of DeviceNet DataRate (DR)</p> <p>The desired baudrate is set according to the table shown below. Note that these switches are only read during power-on.</p>
Sw2.3-Sw2.8	<p>Setting of DeviceNet Node Address (NA)</p> <p>The address (0-63) is set as the DIP-switches are binary coded, so that Sw2.8 is LSB and Sw2.3 is MSB. Note that these switches are only read during power-on.</p>

The baudrate of the MCE9637 module is set according to this table:

Sw2.2	Sw2.1	Baudrate
OFF	OFF	125 kbps
ON	OFF	250 kbps
OFF	ON	500 kbps
ON	ON	Not allowed

6.11.4 Jumpers

The MCE9637 module is equipped with 5 internal jumpers that function as follows:

JUMPER	FUNCTION
JU2	Test mode JU2 OFF: Normal mode (Default at delivery. Shouldn't be changed). JU2 ON: Test mode. The jumper <u>must</u> be OFF during normal operation.
JU3	Baudrate on the AUX bus. OFF: Communication at 115200 bps. ON: Communication at 9600 bps. (Normally the jumper will NOT be mounted on delivery.)
JU4	<i>Reserved for future use</i>
JU5	<i>Reserved for future use</i>
JU6	Test mode JU6 OFF: Normal mode (Default at delivery. Shouldn't be changed). JU6 ON: Test mode. The jumper <u>must</u> be OFF during normal operation.

6.11.5 Light Emitting Diodes

The MCE9637 module is equipped with 6 LED's that function as follows:

LED	FUNCTION
TxBB (Green LED)	Communication with AUX-master The MCE9637 is communicating with AUX-master.
D1 (Yellow LED)	DeviceNet Voltage Detected The MCE9637 module has detected DeviceNet voltage on the DeviceNet connector.
D2 (Red LED)	Communication with AUX-master Toggles when the MCE9637 module receives a valid telegram on the AUX-bus.
TxCAN (Green LED)	CAN bus TxD (Transmit Data) The MCE9637 module transmits data across the CAN bus.
MS (Green/Red LED)	Module Status LED The MCE9637 Module Status LED, that can be lit/flashing in different colours depending on the status of the module. The function of the MS LED is given in the table below.
NS (Green/Red LED)	Network Status LED The MCE9637 Network Status LED, that can be lit/flashing in different colours depending on the status of the network. The function of the NS LED is given in the table below.

Please note that the LED's will flash shortly during power-up during the selftest of the module. The MS and NS LED's will shortly flash Green/Red. The MS and NS LED's can in conjunction with the table below be used for error finding.

Light emitting diode	Colour	Status	Description
MS	Green	ON	Normal Operation. Communication performed normally.
		Flashing	Standby State. The unit needs supervision.
	Red	ON	Unrecoverable fault. A timer error, memory error or other system error. The unit may need replacing.
		Flashing	Recoverable fault. Configuration error, DIP-switch not set correct or similar error. Correct error and restart unit.
	---	OFF	No power. The power is disconnected or the unit is being restarted.
	NS	Green	ON
Flashing			On-Line, No Connection. The unit is On-Line but no connection to the master has been established.
Red		ON	Critical Communication Error. The unit has detected an error that makes it impossible to communicate on the network (duplicate MAC Id or Bus-Off error).
		Flashing	Communication Time-Out. One or more I/O connections are in the Time-Out state.
---		OFF	No power/Off-line. The device may not be powered.

6.11.6 EE-bus connector

The MCE9637 module is equipped with a ten pole connector for connection to the AUX-bus via a MCE9601 module. Hereby connection to the 5024G terminal as well as connection to the power supply for the MCE9637 module is achieved. The connection to the MCE9601 module is made by the supplied flat cable, which has a variable number of mounted connectors depending on the total number of AUX-slaves that has to be connected.

The MCE9601 module is connected to the 5024G terminal as follows:

<u>MCE9601 Terminal</u>	<u>Connection</u>
GND	Not used
B	5024G J4.1: RS485-B
A	5024G J4.2: RS485-A
GND	5024G J4.3: 0 VDC (GNDin)
+24V	+24VDC (Vin)
GND	Not used
I/O	Not used

6.12 DeviceNet connector

The MCE9637 module is equipped with a 5 pole connector for connection to DeviceNet. The connection is according to the DeviceNet specification and is made as follows:

<u>J2 Connector</u>	<u>Function</u>	<u>Colour</u>
J2.1	V-	(Black)(0VDC input)
J2.2	CAN_L (Blue)	
J2.3	SHIELD	(Grey)
J2.4	CAN_H (White)	
J2.5	V+	(Red)(24VDC input)

7) Appendices

7.1 Appendix A: Filters

Two types of filters can be applied: A filter on each sampling from the loadcell and/or a filter on each display weight reading update. The sampling frequency depends on the types and number of loadcells and the weight display reading update rate, as described below. The weight display reading update rate and the filter selection is done in the **WEIGHT DISPLAY** screen as described above (Section 3.14.2 Filters).

All filters are FIR filters with 7-100 taps.

7.1.1 Sampling filter

The sampling frequency and the filter frequency depend on the type and number of loadcells.

Please notice that filtering is a time consuming operation – so selecting a long filter (with many taps) on small sample rates (2-5 ms) may slow operation considerably down or even stop Ethernet or loadcell communication. A combination of a short sampling filter and a display filter or a higher display update time is a better choice and will prevent these problems.

Loadcell type	4000	2000	2000	2000	2000	
Number of loadcells	1-4	1	2	3	4	
Sampling time	2	5	10	15	20	
Filter		Filter frequency (hz) and total settling time (ms)				
Taps	Damping					
7	-60dB	120 Hz 14 ms	48 Hz 35 ms	24 Hz 70 ms	16 Hz 105 ms	12 Hz 140 ms
9	-60dB	100 Hz 18 ms	40 Hz 45 ms	20 Hz 90 ms	13 Hz 135 ms	10 Hz 180 ms
9	-80dB	120 Hz 18ms	48 Hz 45ms	24 Hz 90ms	16 Hz 135ms	12 Hz 180ms
12	-60dB	80 Hz 24 ms	32 Hz 60 ms	16 Hz 120 ms	11 Hz 180 ms	8 Hz 240 ms
12	-80dB	100 Hz 24 ms	40 Hz 60 ms	20 Hz 120 ms	13 Hz 180 ms	10 Hz 240 ms
15	-80dB	80 Hz 30 ms	32 Hz 75 ms	16 Hz 150 ms	11 Hz 225 ms	8 Hz 300 ms
17	-60dB	60 Hz 34 ms	24 Hz 85 ms	12 Hz 170 ms	8 Hz 255 ms	6 Hz 340 ms
21	-80dB	60 Hz 42 ms	24 Hz 105 ms	12 Hz 210 ms	8 Hz 315 ms	6 Hz 420 ms
25	-60dB	40 Hz 50 ms	16 Hz 125 ms	8 Hz 250 ms	5 Hz 375 ms	4 Hz 500 ms
32	-80dB	40 Hz 64 ms	16 Hz 160 ms	8 Hz 320 ms	5 Hz 480 ms	4 Hz 640 ms
50	-60dB	20 Hz 100 ms	8 Hz 250 ms	4 Hz 500 ms	2,7 Hz 750 ms	2 Hz 1000 ms
64	-80dB	20 Hz 128 ms	8 Hz 320 ms	4 Hz 640 ms	2,7 Hz 960 ms	2 Hz 1280 ms
67	-60dB	15 Hz 134 ms	6 Hz 335 ms	3 Hz 670 ms	2 Hz 1005 ms	1,5 Hz 1340 ms
85	-80dB	15 Hz 170 ms	6 Hz 425 ms	3 Hz 850 ms	2 Hz 1275 ms	1,5 Hz 1700 ms
100	-60dB	10 Hz 200 ms	4 Hz 500 ms	2 Hz 1000 ms	1,3 Hz 1500 ms	1 Hz 2000 ms

Please notice that filtering is a time consuming operation – so selecting a long filter (with many taps) on small sample rates (2-5 ms) may slow operation considerably down or even stop Ethernet or loadcell communication. A combination of a short sampling filter and a display filter or a higher display update rate is a better choice and will prevent these problems.

7.1.2 Display filter

The filter frequency depends on the weight display reading update rate. Examples are given in the table below:

Update period (ms)		20	100	200	400
Filter		Filter frequency (hz) and total settling time (ms/s)			
Taps	Damping				
7	-60dB	12 Hz 140 ms	2,4 Hz 700 ms	1,2 Hz 1,4 s	0,6 Hz 2,8s
9	-60dB	10 Hz 180 ms	2,0 Hz 900 ms	1,0 Hz 1,8 s	0,5 Hz 3,6 s
9	-80dB	12 Hz 180 ms	2,4 Hz 900 ms	1,2 Hz 1,8 s	0,6 Hz 3,6 s
12	-60dB	8 Hz 240 ms	1,6 Hz 1,2 s	0,8 Hz 2,4 s	0,4 Hz 4,8 s
12	-80dB	10 Hz 240 ms	2,0 Hz 1,2 s	1,0 Hz 2,4 s	0,5 Hz 4,8 s
15	-80dB	8 Hz 300 ms	1,6 Hz 1,5 s	0,8 Hz 3 s	0,4 Hz 6 s
17	-60dB	6 Hz 340 ms	1,2 Hz 1,7 s	0,6 Hz 3,4 s	0,3 Hz 6,8 s
21	-80dB	6 Hz 420 ms	1,2 Hz 2,1 s	0,6 Hz 4,2 s	0,3 Hz 8,4 s
25	-60dB	4 Hz 500 ms	0,8 Hz 2,5 s	0,4 Hz 5 s	0,2 Hz 10 s
32	-80dB	4 Hz 640 ms	0,8 Hz 3,2 s	0,4 Hz 6,4 s	0,2 Hz 12,8 s
50	-60dB	2 Hz 1,0s	0,4 Hz 5 s	0,2 Hz 10 s	0,1 Hz 20 s
64	-80dB	2 Hz 1,28 s	0,4 Hz 6,4 s	0,2 Hz 12,8 s	0,1 Hz 25,6 s
67	-60dB	1,5 Hz 1,34 s	0,3 Hz 6,7 s	0,15 Hz 13,4 s	0,075 Hz 26,8 s
85	-80dB	1,5 Hz 1,70 s	0,3 Hz 8,5 s	0,15 Hz 17 s	0,075 Hz 34 s
100	-60dB	1 Hz 2,0 s	0,2 Hz 10 s	0,1 Hz 20 s	0,05 Hz 40 s

8) How to contact Alfa Laval Tank Equipment

For further information please feel free to contact:

Alfa Laval Tank Equipment

Alfa Laval Kolding A/S

31, Albuen - DK 6000 Kolding - Denmark

Registration number: 30938011

Tel switchboard: +45 79 32 22 00 - Fax switchboard: +45 79 32 25 80

www.toftejorg.com , www.alfalaval.dk - info.dk@alfalaval.com

Contact details for all countries are continually updated on our websites.

9) EC Declaration of Conformity



EC Declaration of Conformity

The designated company

Alfa Laval Kolding A/S

Company name

Albuen 31, 6000 Kolding, Denmark

Address

+ +45 79 32 22 00

Phone no.

hereby declare that

Alfa Laval Weighing Terminal

Denomination

TE67X000005024

Type

valid for serial numbers from 2014-00001 and subsequent serial numbers.

is in conformity with the provisions of the Directive 73/23/EEC appendix IIIB and directive 89/356/EEC.

And furthermore declares that the following (parts/clauses of) applicable directives have been used:

- EN 61010 Part 1 (Safety requirements for electrical equipment for measurements control and laboratory use)
- EN 60529 (degrees of protection provided by enclosures)
- EN50081 part 1 (EMC, generic emission standard)
- 50082 part 2 (EMC, generic immunity standard)

The technical construction file for this instrument is retained at the above address.

R&D Manager

Title

Henrik Falster Hansen

Name

Signature

September 9, 2014

Date

Alfa Laval Kolding A/S

Company



How to contact Alfa Laval

Contact details for all countries are continually updated on our website.

Please visit www.alfalaval.com to access the information directly.

© Alfa Laval Corporate AB

This document and its contents is owned by Alfa Laval Corporate AB and protected by laws governing intellectual property and thereto related rights. It is the responsibility of the user of this document to comply with all applicable intellectual property laws. Without limiting any rights related to this document, no part of this document may be copied, reproduced or transmitted in any form or by any means (electronic, mechanical, photocopying, recording, or otherwise), or for any purpose, without the expressed permission of Alfa Laval Corporate AB. Alfa Laval Corporate AB will enforce its rights related to this document to the fullest extent of the law, including the seeking of criminal prosecution.