



## Alfa Laval Unique Mixproof Horizontal Tank Valve (Unique HT)

State of the art - cleanability

### Concept

This Unique Mixproof HT Valve is specially designed for horizontal mounting on the side of a tank or as a space-saving alternative at the bottom of a cone-formed tank. Based on the well proven and exceptionally versatile principle of the Unique Mixproof valves, this horizontal mixproof tank valve features many of the same components, such as the actuator, yoke and seals, and therefore the same spare parts. This provides the benefits of easy serviceability and low total cost of ownership.

### Standard design

The Unique Mixproof HT valve, which can be fitted with any level of sensing and control. It is as standard supplied with seat lift, which enables handling of two different products at the same time, or safe handling of one product while seat-lift cleaning operations are being conducted in the other portion of the valve – all without any risk of cross-contamination.

The double tangential design of the valve body ensures full drainability, especially when the valve is mounted at the bottom of a flat-bottomed tank.



### TECHNICAL DATA

Max. product pressure in pipeline: . . . . . 1000 kPa (10 bar)  
 Min. product pressure: . . . . . Full vacuum.  
 Temperature range: . . . . . -5°C to +125°C (depending  
 on rubber quality)  
 Air pressure: . . . . . Max. 8 bar (800 kPa).

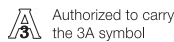

### PHYSICAL DATA

Product wetted steel parts: . . . . . 1.4404 (316L).  
 Other steel parts: . . . . . 1.4301 (304).  
 External surface finish . . . . . Semi-bright (blasted)  
 Internal surface finish . . . . . Bright (polished), Ra < 1.6 µm  
 Product wetted seals: . . . . . EPDM.

Other seals:  
 CIP seals: . . . . . EPDM  
 Actuator seals: . . . . . NBR  
 Guide strips: . . . . . PTFE

### Valve body combination

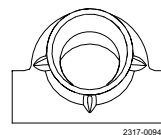

Welding ends

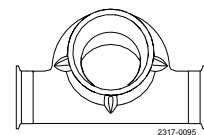

Clamp ends

**State of the art – Cleanability**

The Unique Mixproof HT valve also provides a state of the art solution when there is no CIP pressure or flow from the tank side to clean the seat and plug. The valve is self-cleaning, thanks to two patented Cleaning-in-Place (CIP) nozzles. The first nozzle is designed specifically for plug cleaning. This double-acting nozzle projects cleaning solution through the tank connection, ensuring complete cleaning of the seat contact surfaces as well as the shadow area of the tank port. The second is a rotating CIP nozzle incorporated into the unit for optimum cleaning of the full-bore leakage chamber.

The design of the single valve body makes it suitable to weld directly on the tank or to connect it via a Tri-clamp

The 4" and 6" models feature a 45-mm opening, which enables the passage of very large particles or efficient handling of high viscosity fluids.

**Options:**

- Male parts or clamp liners in accordance with required standard.
- Control and Indication: ThinkTop or ThinkTop Basic.
- Side indication for detection of upper seat lift
- Product wetted seals in HNBR, NBR or FPM
- CIP validation kit that enables monitoring of CIP flow to internal CIP nozzles - See fig. 1

**CIP validation kit**

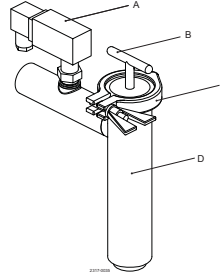

- A. Flow switch
- B. Filter element
- C. Clamp ring
- D. Filter house

fig. 1

Size Inch	Max. size of particle (mm)	Max. tank pressure (bar)	Actuator size 4-Basic (ø157x254)	Actuator size 5-Basic (ø185x280)	Opening pressure in pipe line at 6 bar air pressure (kPa)
2½"	32	5.9	Standard		1000
3"	32	5.9	Standard		1000
4"	45	5.9		Long stroke	1000

**Notes:**

Max. pressure in tank means that a higher pressure in tank will open the valve.

It is possible to open with 10 bar (1000 kPa) in pipe line.

When closing the valve the pressure can not be higher than "Max. Tank pressure".

\* Max. tank pressure seat push tank plug.

## Pressure drop/capacity diagrams

Unique Mixproof Horizontal Tank Valve - to tank

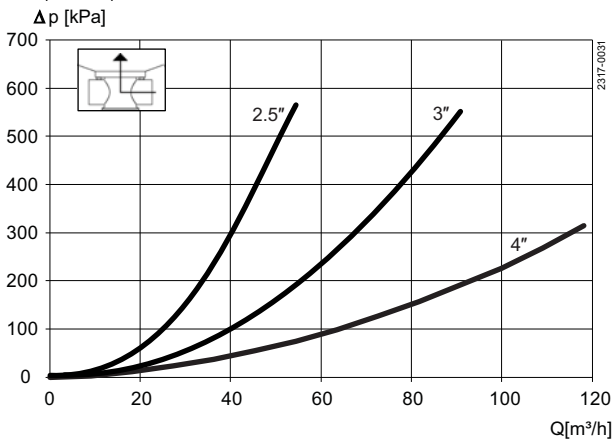

Unique Mixproof Horizontal Tank Valve - straight through

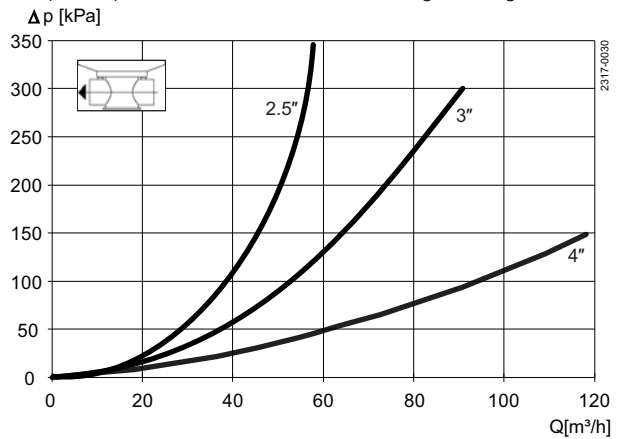

Unique Mixproof Horizontal Tank Valve - from tank

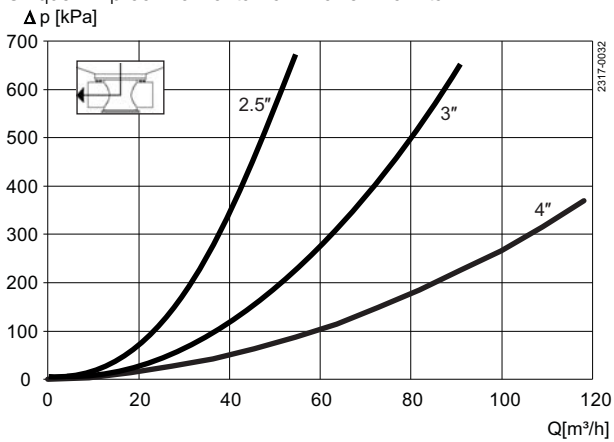

## Air and CIP Consumption

Size ISO	DN/OD			
	2½"	3"	4"	6"
<b>Kv-value</b>				
Upper Seat-lift [m³/h]	2.5	2.5	3.1	7.1
Lower Seat-lift (tank seat lift) [m³/h]	11.5	11.5	34.1	80.5
<b>Air consumption</b>				
Upper Seat-lift * [n litre]	0.4	0.4	0.62	0.62
Lower Seat-lift (tank seat lift) * [n litre]	0.13	0.13	0.21	0.21
Main Movement * [n litre]	1.62	1.62	3.54	3.54
<b>Kv-value - SpiralClean</b>				
External CIP in leakage chamber [m³/h]	1.52	1.52	1.52	1.52

### Note

\* [n litre] = volume at atmospheric pressure

Recommended min. pressure for External CIP in leakage chamber 3 bar.

### Formula to estimate CIP flow during seat lift:

(for liquids with comparable viscosity and density to water):

$$Q = K_v \cdot \sqrt{\Delta p}$$

$$Q = \text{CIP - flow (m}^3\text{/h)}$$

$K_v$  =  $K_v$  value from the above table.

$\Delta p$  = CIP pressure (bar).

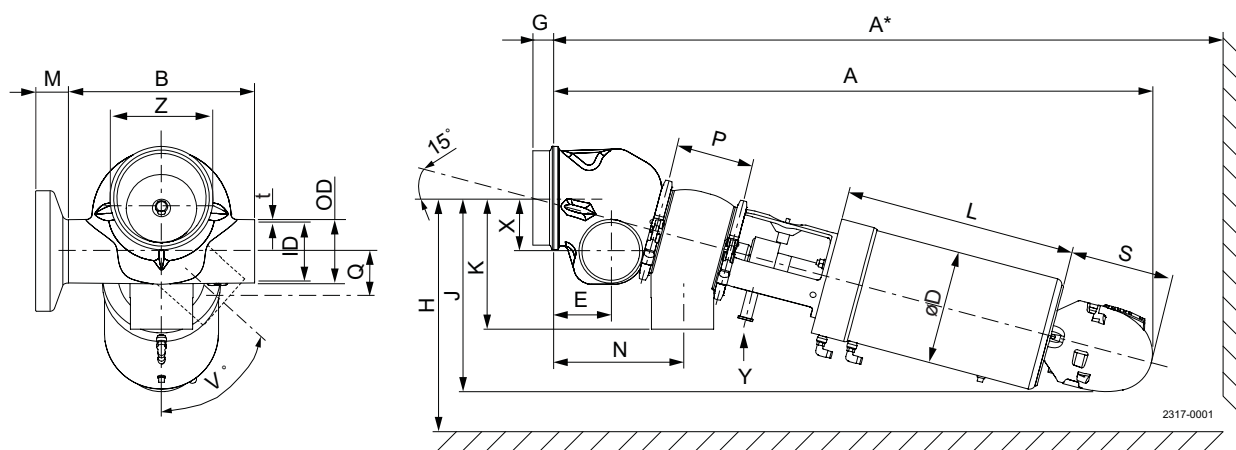

Size	2.5"	3"	4"	6" (75 mm) stroke
A	735	759	977	1088
A*	867	904	1155	1329
B	220	220	300	420
OD	63.5	76.1	101.6	154.2
ID	60.3	72.9	97.6	146.86
t	1.6	1.6	2	3.67
øD	186	186	186	186
E	70.9	77.2	92.2	129.5
F1	38	38	75	75
F2 (Tank plug)	10	10	10	10
G	15.9	15.9	38.1	44.5
H	281	291	364	423
J	246	252	317	359
K	153	158	215	307
L	252	252	379	379
N	152	170	210	283
P	89.3	101.9	126.6	180
Q	15.9	15.9	38.1	44.5
S	180	180	180	180
V°	0-67°	0-60°	0-53°	0-49°
X	38,3	36,6	52,6	93,8
Y	3/4" clamp ferrule	3/4" clamp ferrule	3/4" clamp ferrule	3/4" clamp ferrule
Z	4"	4"	6"	10"
M/Tri-clamp	21	21	21	38.56
Weight (kg)	13.0	14.2	43.1	87.6

Alfa Laval reserves the right to change specifications without prior notification.

#### How to contact Alfa Laval

Contact details for all countries are continually updated on our website. Please visit [www.alfalaval.com](http://www.alfalaval.com) to access the information direct.